



CEMB

BALANCING MACHINES

EN

Use and maintenance manual

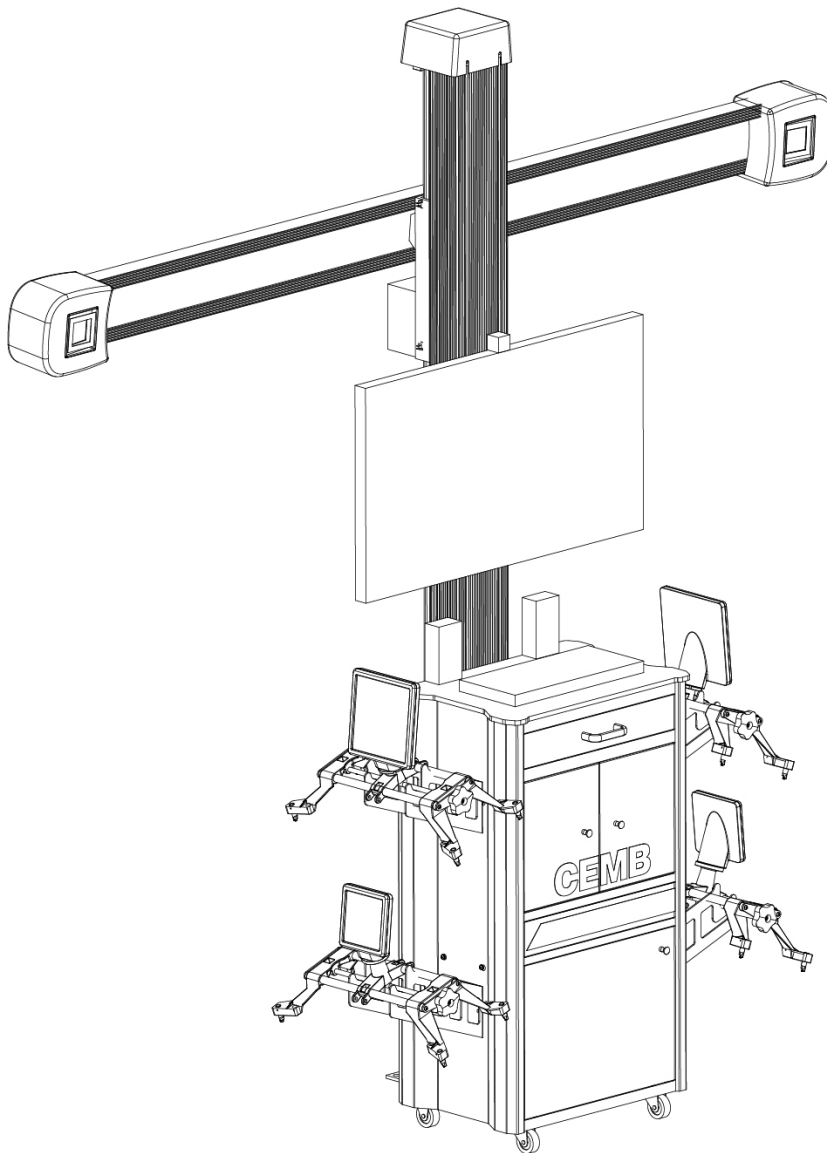

DWA3500

CEMB S.p.A.

Via Risorgimento, 9

23826 Mandello del Lario (LC) ITALY

Telefono: + 39 706369 Fax: + 39 0341 700725

www.cemb.com garage@cemb.com

The Manufacturer declines all liability for any damage to people or property caused by incorrect use of this product.
Subject to change without prior notice.



Istruzioni originali

Translation of the original instructions

Traduction de la notice originale

Übersetzung der Originalanweisungen

Traducción de las instrucciones originales

Tradução das instruções originais

**CONTENTS**

CAUTION!	3
GENERAL WARNINGS	3
PRECAUTIONS AND INSTRUCTIONS FOR SAFETY, USE AND MAINTENANCE	3
1 - MACHINE DESCRIPTION	5
1.1 - TECHNICAL DATA	5
2 - PROGRAM FLOW	6
2.1 - HOW TO INTERACT WITH THE PROGRAM	7
3 - PREPARING FOR MEASUREMENT	8
3.1 - HOME PAGE	8
3.2 - SETTINGS	9
3.2.1 - PRINT SETTINGS	10
3.2.2 - DATA EXPORT SETTING	11
3.3 - CUSTOMER DATABANK	12
4 - VEHICLE SELECTION	13
4.1 - SELECTING A VEHICLE	13
4.2 - CUSTOMER INFORMATIONS	13
5 - VEHICLE SPECIFICATIONS	14
5.1 - ADJUSTMENT HELP IMAGES	15
5.2 - RIDE HEIGHT	16
5.3 - LOADS	17
5.4 - VEHICLE CUSTOMISATION	17
6 - TARGET ACQUISITION AND VEHICLE POSITIONING SEQUENCE	19
6.1 - ACQUISITION WITH WHEELS RAISED	20
6.2 - 2-TARGET MODE (ONLY FOR HIGH VERSION)	20
7 - STEERING	21
7.1 - CASTER AND SAI MEASUREMENT	21
7.2 - TOOT MEASUREMENT	22
7.3 - MAXIMUM STEERING	22
8 - DIAGNOSTICS	23
8.1 - AUDIT	23
9 - ADJUSTMENT	24
9.1 - ADJUSTMENT PROCEDURES	25
9.2 - ADJUSTING A REAR AXLE	25
9.3 - ADJUSTING A FRONT AXLE	26
9.4 - ADJUSTING THE FRONT TOE-IN WITH THE VEHICLE RESTING ON A SUPPORT (TOE-IN CURVE - VAS PROCEDURE)	27
9.5 - ADJUSTING WITH THE WHEELS RAISED OR STEERED (FREEZING)	29
10 - SUMMARY	30
10.1 - VEHICLE DIMENSIONS (ONLY FOR HIGH VERSION)	31

► **General warnings**

- The manual refers to the essential requirements set out in the directives, standards and provisions pertaining to use of the machine summarising the most significant points.
- In addition to the service instructions, the general rules of law and the binding rules regarding the prevention of accidents and protection of the environment must be observed.
- For all the work to be carried out with or on the machine, the following provisions must be complied with as well as the general safety regulations following the instructions.
- The user must ensure that the machine is always and only used in perfect condition taking into account the essential safety requirements and the applicable regulations.
- The machine must immediately be put out of service if any defects or malfunctioning is found.
- Only trustworthy persons may work with the machine; the user is responsible for ensuring that the persons assigned to the job are suitably qualified and trained.
- For any doubts about use and maintenance of the machine, consult this manual; if necessary, contact the authorised technical service centres.

► **Precautions and instructions for safety, use and maintenance**

- The data plate bearing the voltage and frequency data is affixed on the rear of the machine. **NEVER CONNECT THE MACHINE TO A VOLTAGE OR FREQUENCY OTHER THAN THOSE INDICATED.**
- The machine is equipped with a 3-wire plug with incorporated earth to be inserted only in an earthed socket. If it is not possible to fit the plug in a socket of this kind, please consult an electrician.
- Do not modify or improperly use the plug.
- This machine is not equipped with a manual power cutting device. To cut the power, pull out the plug or turn off the main switch positioned upstream.
- All the operations on live electrical parts must be performed after turning off the power switch on the electric cabinet.
- Do not remove or make unrecognizable the danger warning plates, adhesive labels and markings on the machine and make sure that they are always legible.
- All the maintenance and inspection operations must exclusively be carried out by qualified persons.
- Mechanical and electrical repairs as well as setting operations may only be carried out by qualified persons.
- Unauthorised persons must be prohibited from performing any work on the machines and equipment of the system.
- In the event of significant faults that may compromise the safety and/or reliability of the machine, it must be stopped and in any case not started before the faults have been corrected.
- It is prohibited to transform or make modifications to the electric system.
- The user will be held responsible for any damages as a result of such modifications. In case of doubt, please contact the manufacturer before making any modifications.
- Exclusively use original fuses with the specified capacity in ampere! In the event of electrical power supply faults, the machine must immediately be turned off.
- Defective fuses may not be repaired or deactivated, but must be replaced with fuses of the same type.
- Comply with the environmental protection regulations when disposing of waste substances or replaced parts.

1 - MACHINE DESCRIPTION

The wheel aligner is a machine intended for measuring the characteristic angles of motor vehicles, in particular, the camber, toe-in and caster.

► 1.1 - Technical data

Power supply and consumption

Measuring cabinet

Power supply:	230 VAC single-phase 50/60 Hz 115 VAC single-phase on request
Max power absorbed:	0,7 kW
Max current absorbed:	3 A - 230V 6 A - 115V



IR LED PROTECTION

There are two different IR (infrared rays) LED protection modes:

- The IR LEDs are on **ONLY** on the measurement pages
- The IR LEDs turn off on the measurement pages if at least 3 targets are not shown for 15 seconds

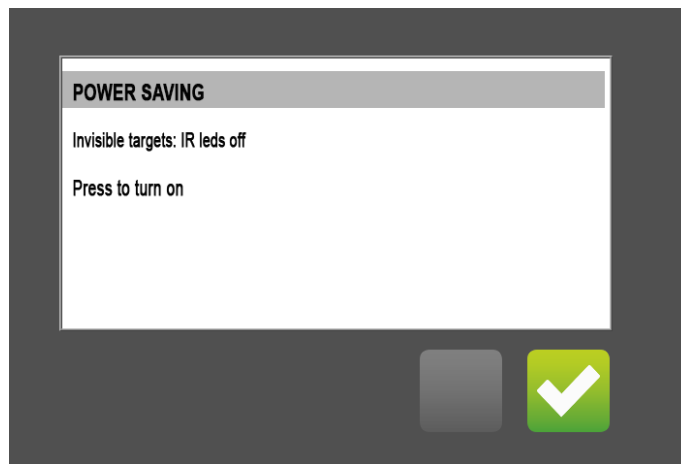

2 - PROGRAM FLOW

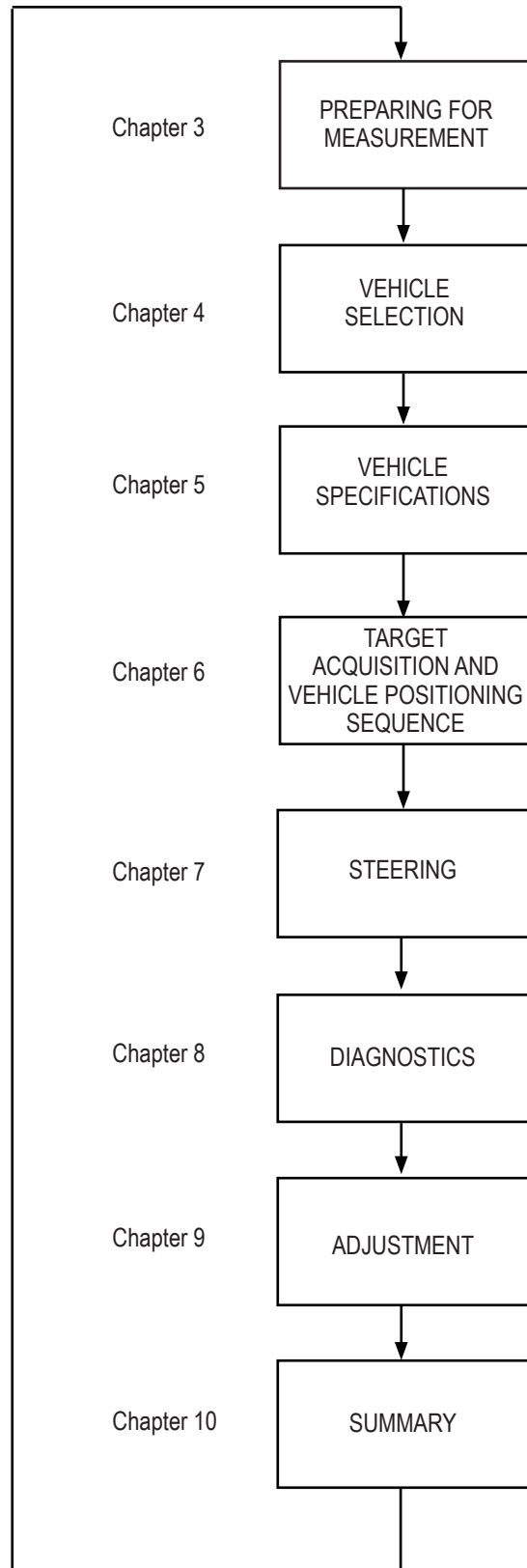

The following flow chart schematizes the typical program flow:











► 2.1 - How to interact with the program

On the normal pages:





The operations indicated by the on-screen keys F1 ... F7 can be performed by clicking on or pressing ...
 on the keyboard or pressing the arrow buttons of the measuring head keypad.

 ... 	: the function of these keys varies from page to page
	: goes back to the previous page
 or 	: goes to the next page
	: help
	: goes back to the home page
	: Power OFF UNDO : cancel shutdown SYSTEM: close the program POWER OFF: turn off the PC

In the menus:



 ... 	: select the desired function
	: exits from the menu

3 - PREPARING FOR MEASUREMENT

► 3.1 - Home page

The home page appears at the beginning of each alignment procedure.

Generally, when the home page is displayed, the preliminary operations on the vehicle are performed.

To prepare for measurement:

1. Lock the turn plates
2. Position the vehicle on the turn plates
3. Turn on the alignment system



If the "databank activation" window appears on the home page the databank must be activated.

- ... : webcam (optional for standard version)
- : camera images
- : menu
- : target acquisition
- : Power OFF
 - UNDO : cancel shutdown
 - SYSTEM: close the program
 - POWER OFF: turn off the PC

► 3.2 - Settings

To access this page from the home page press **F3** then **F1**

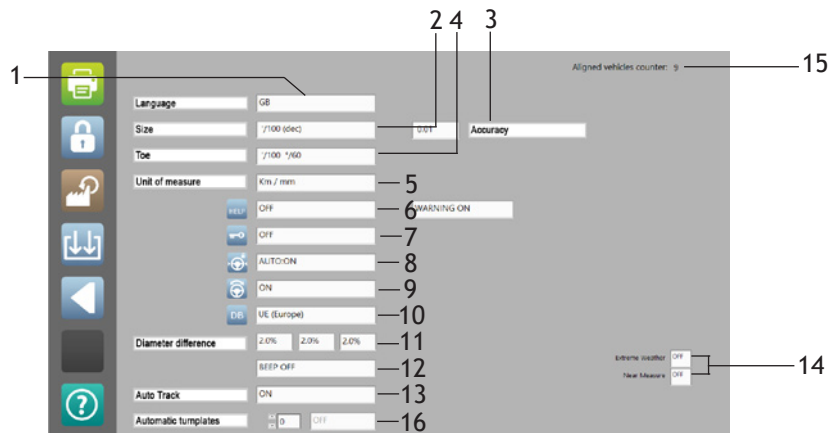





The following parameters can be set:

- Language
- Format of the fractions of an angle
 - '/100 (dec) = hundredths of a degree (centesimal degrees)
 - °/60 (min) = sixtieth of a degree (sexagesimal degrees)
- Angle resolution shown on the display (the actual resolution of the instrument does not change)
- Toe-in format and resolution
 - '/100 °/60 = degrees, resolution specified in box 6
 - mm = millimetres, resolution specified in box 8
 - inch (dec) = inches, resolution in tenths of an inch
 - inch (1/4) = inches, resolution in fourths of an inch
 - inch (1/64) = inches, resolution in sixty-fourths of an inch
- Distance unit of measure
- Help texts:
 - OFF: disabled
 - ON: displays on the screen buttons their name
 - ON+INF: displays the previous and pages titles
- Settings page password ('ON' = password required to access the Settings page)
- Automatic next page for the brake pedal lock and steering lock positioning pages



AUTO ON: the next page is automatically displayed after 15 seconds

AUTO OFF: you need to press F6 to go to the next page
- Option to disable caster measurement:
 - ON: steering required
 - OFF: steering not required
- Car database active
- Wheel diameter check precision
- Beep OFF/ON
- Automatic OFF/ON cameras positioning
- Near Measure/Extreme Weather Condition: these options can be used individually or in combined mode whenever you have minimal oscillations in the measurements (in particular, total and partial toe-in). In the event of value oscillations for unknown causes, it is suggested to try the best combination between the two functions
- Number of alignments executed
 - F1** : print settings
 - F2** : databank/software activation
 - F3** : reset to factory settings
 - F4** : data export setting
 - F5** : saves the settings and exits
- Automatic plates ON/OFF (optional for High version)
- Automatic plates serial port (optional for High version)

-  : print settings
-  : databank/software activation
-  : reset to factory settings
-  : data export setting
-  : saves the settings and exits

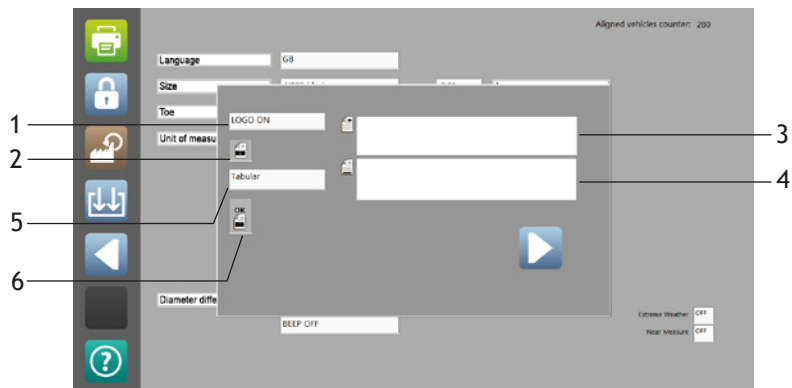
► 3.2.1 - Print settings



1. Logo ON/OFF
2. Colour in which out-of-tolerance values are printed
 -  : measurements before and after adjustment red
 -  : measurements before and after adjustment black
 -  : only measurements after adjustment (black)
3. Printer header
4. Print footer
5. Tabular or graphic print out
6. Green or black for values in tolerance

-  : saves the settings and exits

► 3.2.2 - Data export setting



It is possible to save automatically and daily any single alignment anywhere in the network. Any file contains the complete daily measurements before and after adjustment.

How to set it:

- Create a new folder where wished to save the data. Any accessible path in the network can be used.
- Enter the SET-UP page and select the DATA EXPORT icon ()

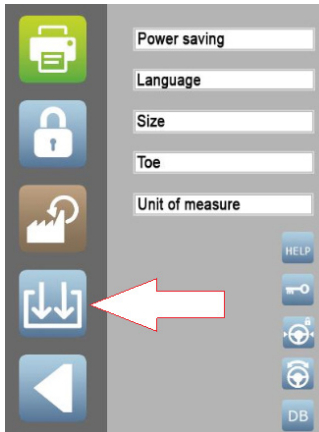



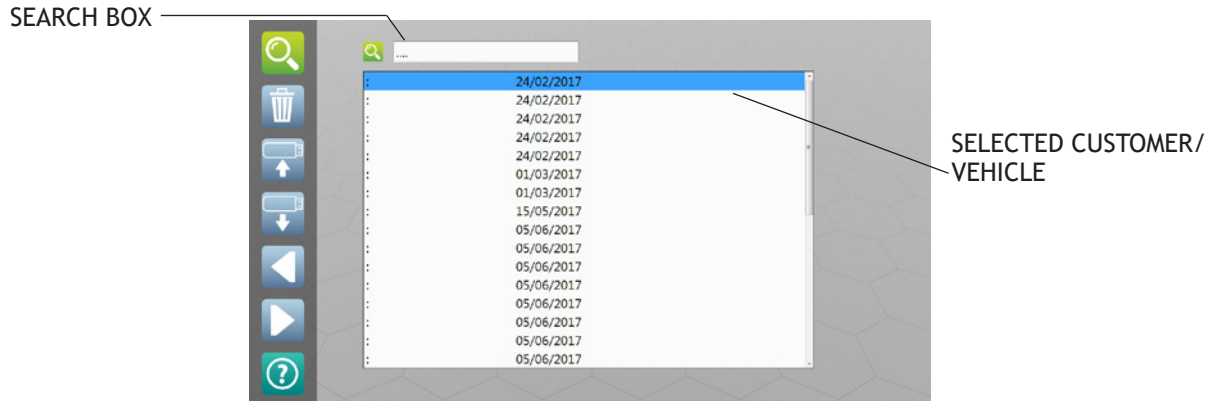

- Click on ENABLE (LED must be on)
- Browse to the folder previously created
- *Optional:* insert the aligner serial number. It will be saved with the data.

► 3.3 - Customer databank

To access this page from the home page press **F3** then **F2**. From this page you can search for and display the customer informations and the relative vehicles measurements stored previously. You can search the data by customer name, vehicle license plate, date or work order. You can also backup or restore all the user data (customer informations and relative vehicles measurements + customized vehicles).



- F1** : displays the list of customers/vehicles corresponding to what was entered in the search box
- F2** : deletes the customer/vehicle selected
- F3** : backup  see below
- F4** : restore  see below
-  /  : select the desired customer
- F6** : displays the customer measurements of the selected customer

To backup the user data:

1. Plug a USB memory into a free USB port.
2. Press **F3**. The user data is copied to the USB memory
3. Copy the user data files from the USB memory to a safe location on another computer

To restore the user data:

1. Copy the user data files to a USB memory
2. Plug a USB memory into a free USB port
3. Press **F4**. The user data is copied to the computer

You can also use this method to transfer the user data from one alignment machine to another.



Restoring the user data deletes any user data already on the computer.

4 - VEHICLE SELECTION

► 4.1 - Selecting a vehicle

The Vehicle Selection page allows selecting a vehicle so that during adjustment you can compare the measurements with the manufacturer's specifications and display adjustment help images.

The vehicle is selected first by manufacturer and then by model and sub-model. For faster selection of the model you can display only the models registered as of the year indicated.

You can also insert informations on a customer, which are saved in the customer databank together with the summary of the measurements so that they can be viewed and printed later.

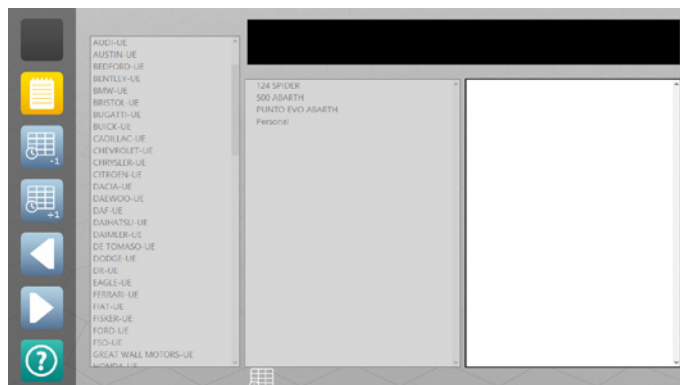

- : to enter informations customer
- , / : to select the desired make
- : confirms the make of the vehicle selected

► 4.2 - Customer informations

Press to insert customer informations.



- : to insert customer informations
- : decreases/increases the year of registration with which the models are filtered
- , / : model selection
- : previous page (vehicle make selection) .
- : confirms the model selected and goes to the database
- : help

5 - VEHICLE SPECIFICATIONS

The Vehicle Specifications page allows analysing the manufacturer's specifications to decide which operations are to be performed.

In most cases the manufacturer specifies the minimum, standard and maximum values for the main angles: toe-in, camber and caster.

Nevertheless, in some cases the manufacturer might:

- Require to position loads in the vehicle or fill the tank before making the measurement and adjustment
- Specify secondary angles: SAI, TOOT or maximum steering
- Specify the maximum values for the difference between the right and left wheel camber or caster
- Prescribe a special adjustment method, as the 'Toe-in curve'
- Give different specifications based on the measurements of the ride height or the inclinations of parts of the suspension.
- Check some vehicle measurements (e.g. ride height or component tightening torque) or apply special tools (e.g. toe-in bar) before making the measurement and adjustment.

You can also set the rim diameter in order to correctly display the toe-in in millimetres or inches and customise the vehicle specifications.

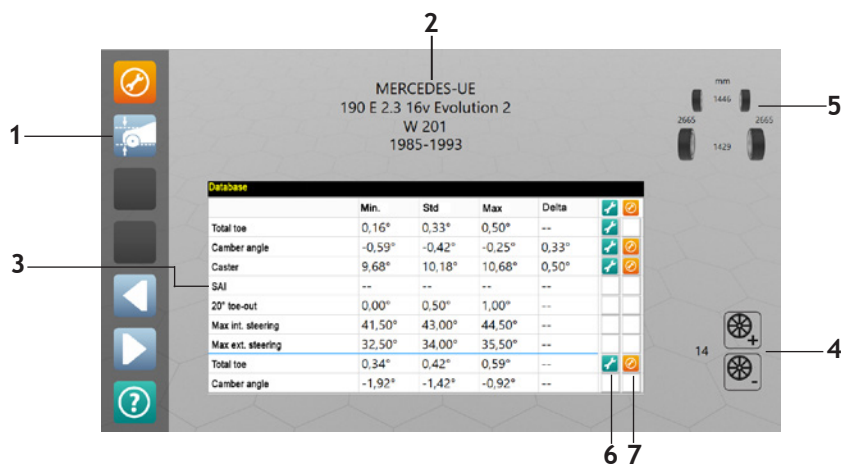

1. Wheelbase and track
2. Vehicle - make, model, sub-model or technical name, date of start and end of production.
3. Specifications. Minimum, standard and maximum values and maximum difference between the right and left wheels.
4. Rim diameter (inches)
5. If VAG icon appears, the manufacturer requires the 'toe-in curve' adjustment method
6. If the wrench icon appears, the vehicle angle is definitely adjustable. If it does not appear, the angle might be adjustable any way.
7. If the camera icon appears during adjustment you can view the adjustment help images.



If you do not set the correct rim diameter when the toe-in is displayed in millimetres or inches, the measurement may differ from what is obtained when measuring the toe-in with a rule. Nevertheless, the rim diameter does not need to be set correctly in order to correctly adjust the vehicle; it is sufficient to position the indicator in the green zone during adjustment.



: displays any Adjustment Help Images [5.1](#)



: displays the Ride Height page [5.2](#)



: displays the weights and percentage fuel in the tank [5.3](#)



+ : allows creating a customised vehicle [5.4](#)



/ : decreases/increases the rim diameter

► 5.1 - Adjustment help images

Selecting this option (F1) a page is displayed showing the images of the mechanical adjustments that can be made on the vehicle being measured.

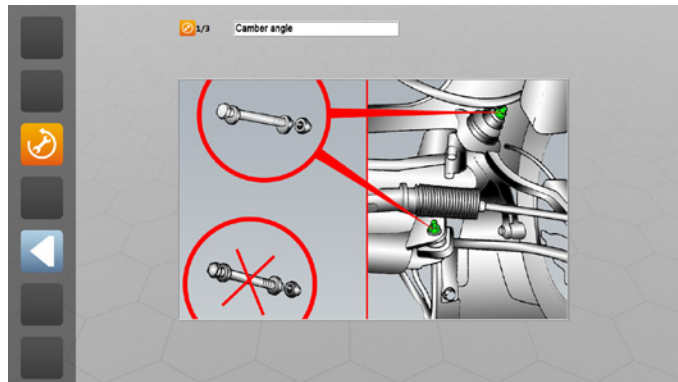

: displays the next image



: goes back to the Vehicle Specifications

► 5.2 - Ride height

To access this page, press  from the Vehicle Specifications page

The Ride Height page allows:

- Viewing which measurements on the vehicle are required by the manufacturer (ride height or inclination of parts of the suspension) and if necessary enter the results.
- Viewing which measurements to check on the vehicle before making the measurement and the adjustment (e.g. chassis height or component tightening torque)
- Viewing which special tools to apply (e.g. toe-in bar)

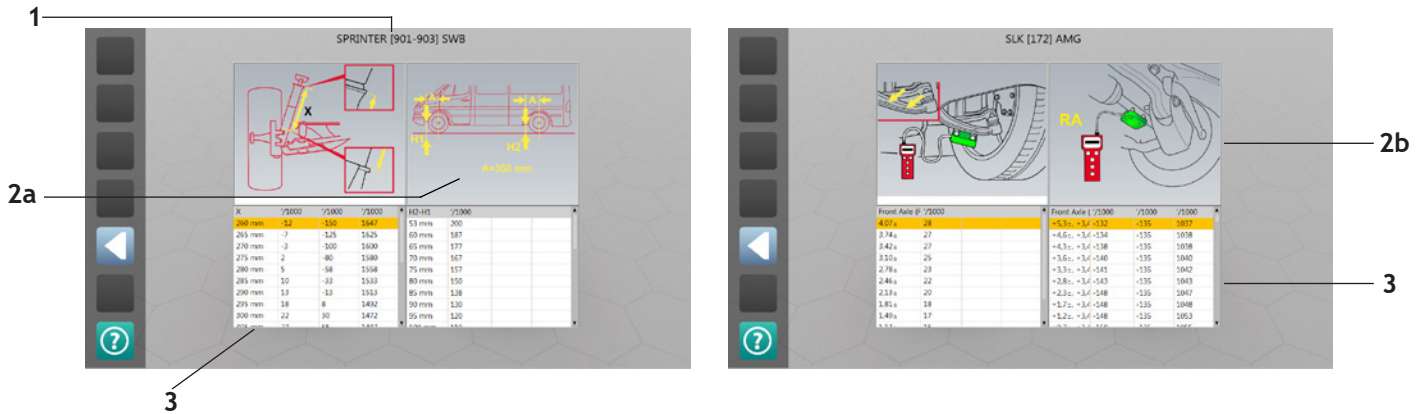

1

2a

2b

3

1. Vehicle
2. Images of the measurements to be made on the vehicle or the tools to be applied. Examples:
 - a. Measurements with rule
 - b. Measurements with inclinometer
3. Tables

Once the tools have been applied and the measurements made, consult the tables.

- If they indicate that you need to check that the measurement is within a certain tolerance interval and this is not the case, act on the vehicle adjustments to bring the measurements within tolerance.
- If they indicate that you need to enter the measurement made, select the row from the corresponding table. The vehicle specifications are modified as a result.



You are advised to follow the manufacturer's indications; if it is required to set the measurement and this is not done, average values are used for the specifications.



: selects the value of the measurement made on the vehicle (used only for tables that indicate that the modification selected must be entered)



: goes back to the Vehicle Specifications page

► 5.3 - Loads

To access this page, press **F3** from the Vehicle Specifications page
 The Loads page allows viewing the loads to be positioned in the vehicle and the amount of fuel there needs to be in the tank as specified by the manufacturer.

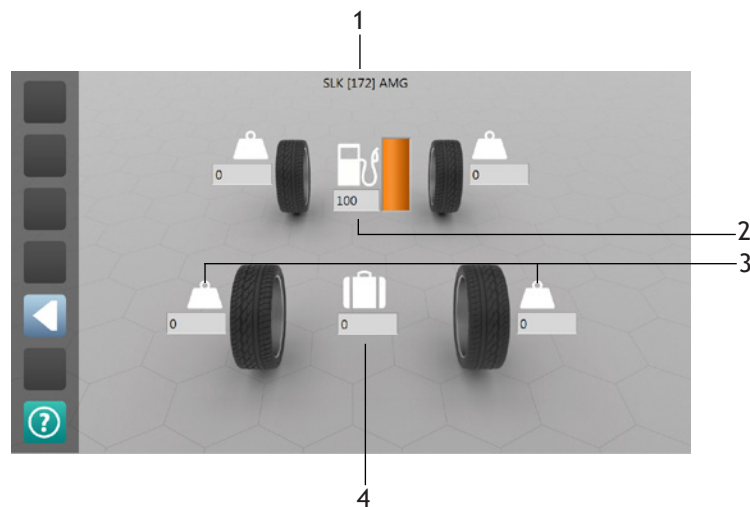

1. Vehicle
2. Percentage fuel in the tank
3. Loads to be positioned on the seats (kg)
4. Loads to be positioned in the luggage compartment (kg)

With reference to the figure check the percentage fuel in the tank and if loads need to be positioned in the passenger and luggage compartments of the vehicle being measured.

F5 : goes back to the Vehicle Specifications page

► 5.4 - Vehicle customisation

To access this page, press **page down** then **F4** from the Vehicle Specifications page
 The Vehicle Customisation page allows adding vehicles to the vehicle database.
 To do this, first select a vehicle on the Vehicle Selection page and then access this page to modify the model and the specifications. Of course, starting from a vehicle with similar specifications to the one to be added will simplify the job.
 On this page you cannot change the vehicle manufacturer, which must therefore be selected first. You cannot add vehicles whose manufacturer is not already in the list of manufacturers on the Vehicle Selection page. There is however a generic manufacturer name called 'Extra' at the end of the list where these vehicles can be added. You cannot add ride height data nor adjustment help images.

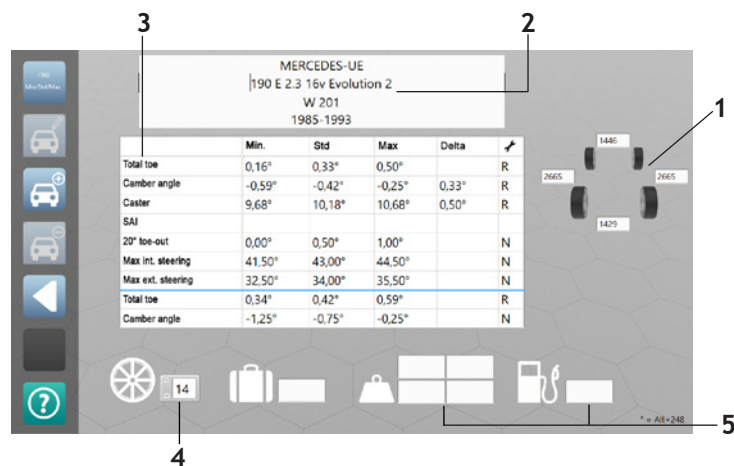

1. Wheelbases and tracks
2. Manufacturer, model, sub-model or technical name, year of registration of the vehicle (enter in the format 'aaaa - bbbb')
3. Angle values. The first 3 columns indicate: Minimum/standard/maximum or standard/upper tolerance/lower tolerance depending on what was selected with . The fourth column indicates the maximum difference between the right and left wheels. The wrench icon indicates whether the angle is adjustable (R = adjustable; N = not adjustable)
4. Rim diameter (inches)
5. Weights and percentage fuel in the tank



: selects the unit of measure and the format of the data to be entered (for the angles)
 /60 = sexagesimal degrees (e.g. 1° 55')
 /100 = centesimal degrees (e.g. 1.55°)
 min/std/max = data in the format minimum/standard/maximum/difference between right and left
 std/toll+/toll- = data in the format standard/upper tolerance/lower tolerance/difference between right and left



: saves the modifications (active only when modifying a customised vehicle created previously).



: creates a new customised vehicle saving the data entered



: deletes the customised vehicle (active only when modifying a customised vehicle created previously).



: goes back to the Vehicle Specifications page selected previously

6 - TARGET ACQUISITION AND VEHICLE POSITIONING SEQUENCE

This screen shows the status of each targets: visible (black) or not visible (red).

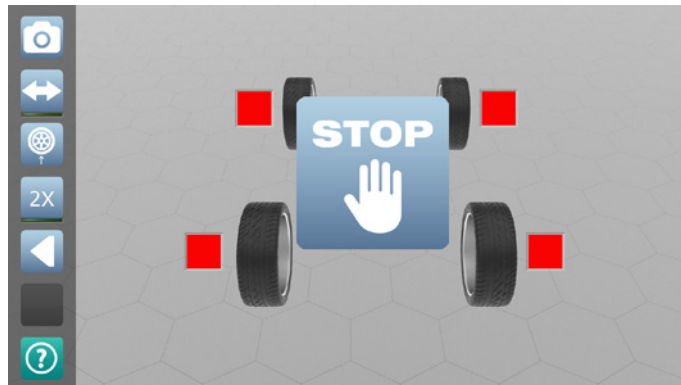

- ... : camera images
- : limits vehicle movement, by split its movement into half forward and half backward
- : acquisition with wheels raised
- : 2-target mode (front)

If all target are visible, the following step is the vehicle positioning:

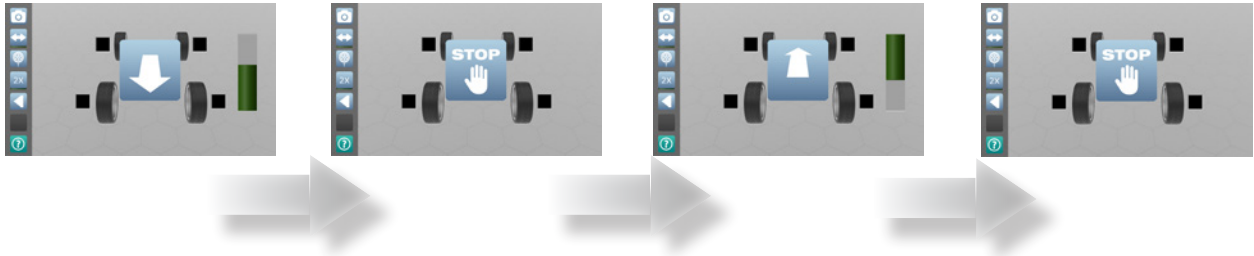

1. Pull the vehicle backward until the STOP signal appear
2. Wait until the STOP signal disappears
3. Pull the car forward until the STOP signal appears

The procedure can also be performed as the following:

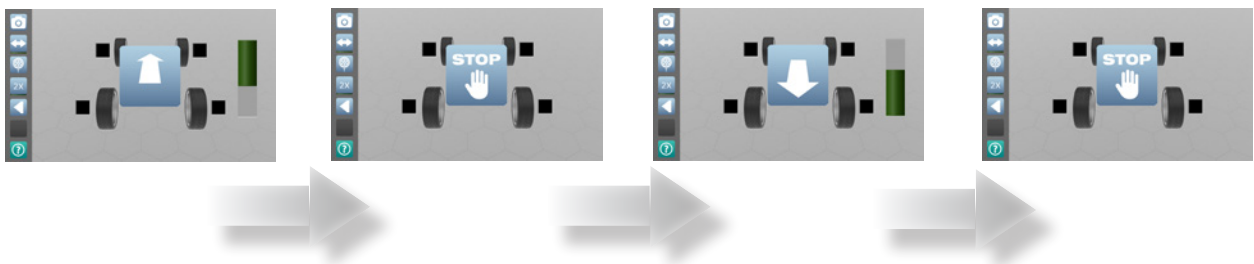

1. Pull the vehicle forward until the STOP signal appear
2. Wait until the STOP signal disappears
3. Pull the car backwards until the STOP signal appears

▶ **6.1 - Acquisition with wheels raised**

The vehicle can be raised to acquire each target individually (useful when needing to remove a wheel or if measuring a vehicle with a long wheelbase on a short car lift).

▶ **6.2 - 2-target mode (only for High version)**

Allows measuring and adjusting only the front axle (recommended for experts only as it does not guarantee that the steering wheel stays straight).

The steering function allows measuring the characteristic steering angles: caster, SAI, TOOT and the maximum steering.

It consists of making several measurements with the wheels steered at different steering angles.

Steering angle indicators

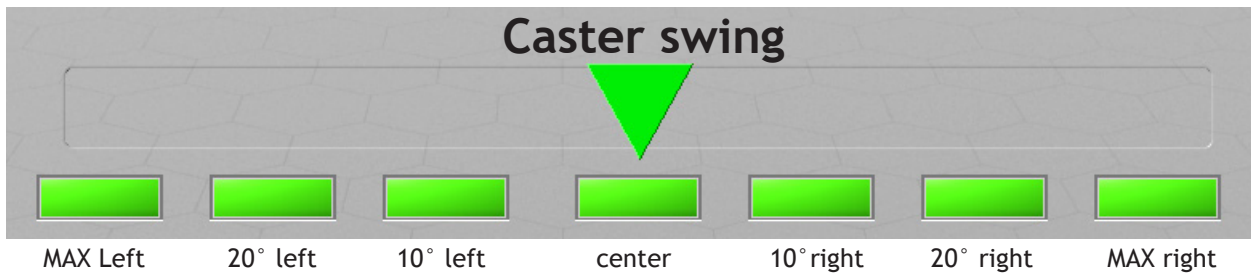

► 7.1 - CASTER and SAI measurement

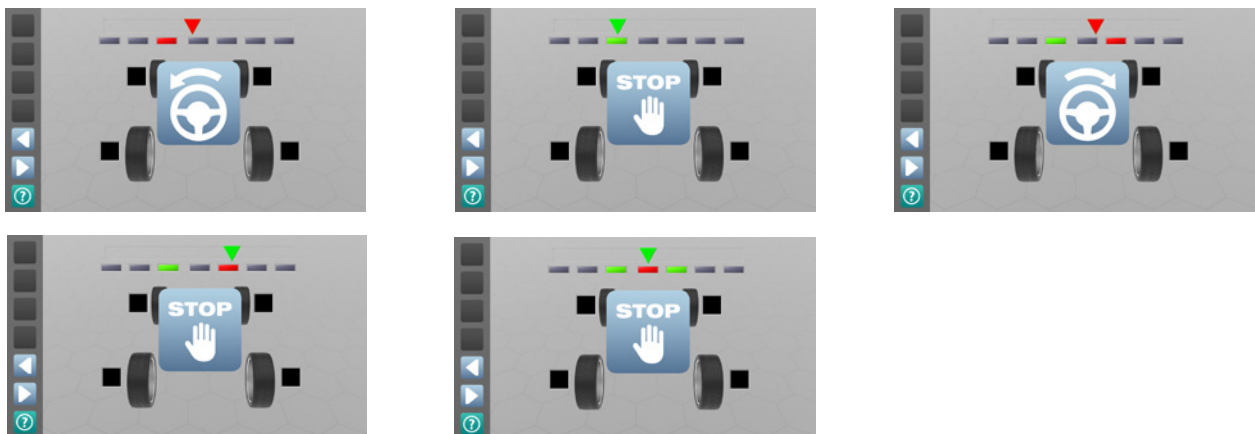

1. Steer left until the 10° left indicator becomes green and the STOP signal appears
2. Wait until the STOP signal disappears
3. Steer right until the 10° right indicator becomes green and the STOP signal appears
4. Wait until the STOP signal disappears
5. Steer left until the center indicator becomes green and the STOP signal appears

► **7.2 - TOOT measurement**

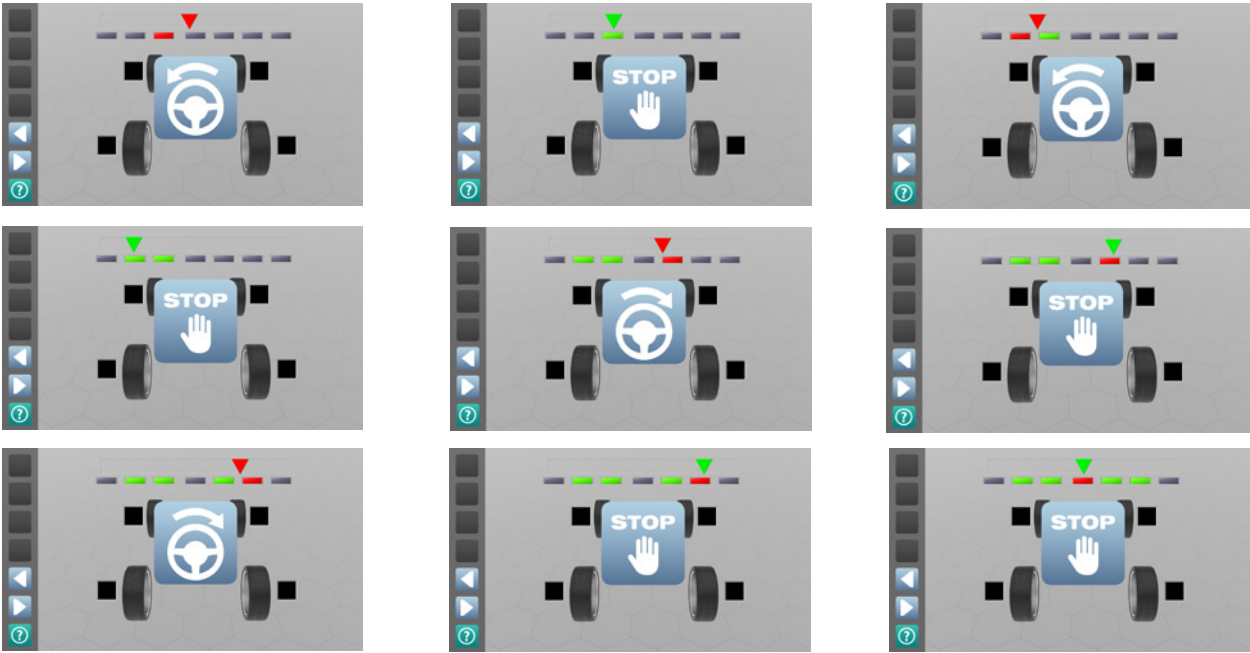

1. Steer left until the 10° left indicator becomes green and the STOP signal appears
2. Wait until the STOP signal disappears
3. Steer left until the 20° left indicator becomes green and the STOP signal appears
4. Wait until the STOP signal disappears
5. Steer right until the 10° right indicator becomes green and the STOP signal appears
6. Wait until the STOP signal disappears
7. Steer right until the 20° right indicator becomes green and the STOP signal appears
8. Wait until the STOP signal disappears
9. Steer left until the center indicator becomes green and the STOP signal appears

► **7.3 - Maximum steering**







1. Perform the left steering as for TOOT measurement steps from 1 to 4
2. Steer left until the maximum mechanical steering of the vehicle has been reached and wait the STOP signal
3. Wait until the STOP signals disappears
4. Steer right as for TOOT measurement steps from 5 to 8
5. Steer right until the maximum mechanical steering of the vehicle has been reached and wait the STOP signal
6. Wait until the STOP signals disappears
7. Steer left until the center indicator becomes green and the STOP signal appears

8 - DIAGNOSTICS





The Diagnostics page displays the measurements made on the vehicle before adjustment, next to the data-bank specifications. The measurements out-of-tolerance are displayed in red so that you can easily identify what to adjust.

Database				Before adjusting			
Min.	Std.	Max.	Delta	Left	Right	Delta	
--	--	--	--	Total toe	0,00°		
				Partial toe	0,00°	0,00°	
				Set-back	0 mm		
--	--	--	--	Camber angle	0,00°	0,00°	0,00°
--	--	--	--	Caster			
--	--	--	--	SAI			
--	--	--	--	TOGT			
--	--	--	--	Total toe	0,00°		
				Partial toe	0,00°	0,00°	
				Set-back	0 mm		
--	--	--	--	Camber angle	0,00°	0,00°	0,00°
				Thrust angle	0,00°		

-  : displays the vehicle dimensions  [10.1](#)
-  : prints the values measured
-  : modifies the Customer Notes  [4.2](#)

► 8.1 - Audit

Audit Function identifies driving problems, resulting from measures not contemplated in the specifications.

Check	
Front total toe	
Front partial toe	
Front camber angle	
Rear total toe	
Rear camber angle	

Possible signs

9 - ADJUSTMENT

During adjustment the wheel angles are continuously measured and displayed so that the effect of the adjustments can immediately be seen.

The main angles are shown both in value

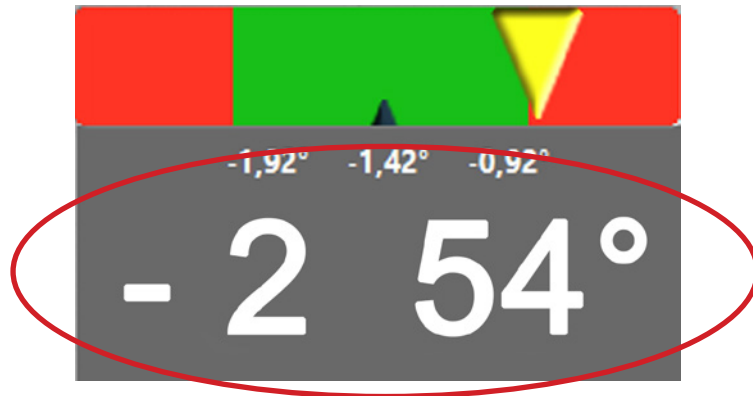

and in graphic form by an indicator on a green and red scale

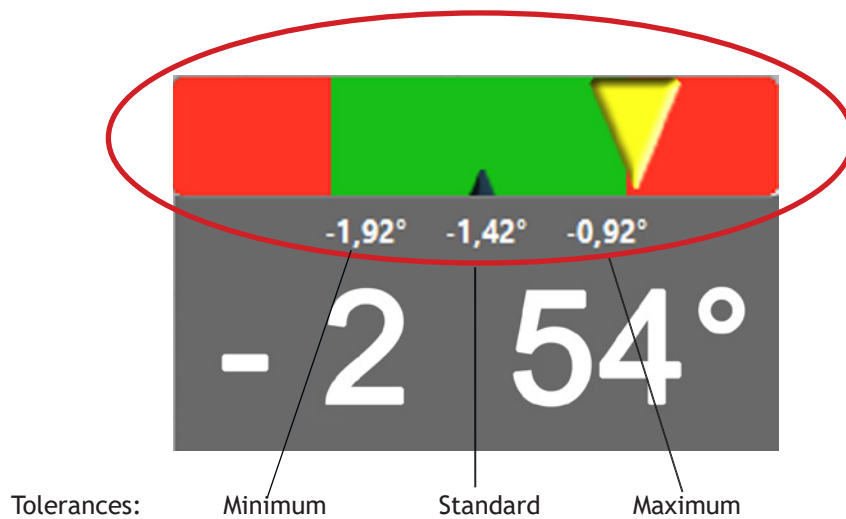

Adjust the angles until the indicator is in the green zone representing the angles in tolerance, while the red zone represents the angles out of tolerance.

► 9.1 - Adjustment procedures

The adjustment procedure depends on the type of vehicle, the measuring mode and the manufacturer's specifications:

- Normal car adjustment procedure
 1. Rear axle adjustment
 2. Front axle adjustment
- VAS car adjustment procedure for vehicles equipped with Multilink suspension
 1. (only in certain conditions established by the program) Front axle adjustment, except toe-in
 2. Rear axle adjustment
 3. (only in certain conditions established by the operator) Front toe-in adjustment with the vehicle resting on a support (toe-in curve)
 4. Front axle adjustment

The software guides you through the adjustment procedure, one by one showing the phases to carry out. The possible phases are described in the following chapters.

► 9.2 - Adjusting a rear axle

The Rear Adjustment page displays the measurements and relative tolerances of the camber and partial and total toe-in of both wheels. It displays also the thrust angle and, in small font, the total toe-in, the difference between the left and right camber and its maximum permitted value.

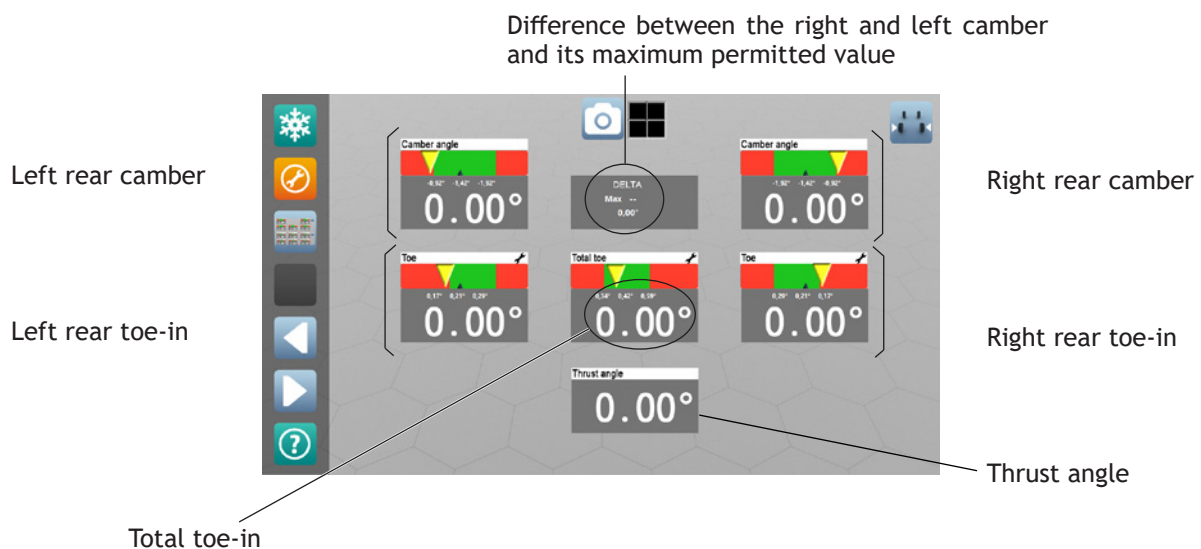

Adjust in order the wheel camber and toe-in until the indicator is in the green zone. The thrust angle is cancelled when the toe-in of the wheels is the same.



For optimal adjustment, first adjust the camber and then the toe-in

If it is difficult to access the adjustment points, you can use the "freezing" procedure to adjust with the vehicle lifted.

To make it easier to identify the adjustment points, use the adjustment help images.

F1 : freezing [9.7](#)

F2 : displays the adjustment help images [5.1](#)

F3 : changes the display from rear axle to front and rear axle simultaneously [9.3](#)

► 9.3 - Adjusting a front axle

Before adjustment of a front axle the following appears:



1. Level the steering wheel and position the steering lock
2. Press **F6** or wait a few seconds for the Front Adjustment page to appear



Correctly level the steering wheel and firmly position the steering lock; this is required to prevent the steering wheel from going askew.

The Front Adjustment page displays the measurements and the relative tolerances of the caster, camber and partial and total toe-in of both wheels in large font. As alternative to the partial toe-in angles you can view the total toe-in and the steering angle.

The differences between the right and left camber and caster and the relative tolerances are also displayed.

Difference between the right and left values and the maximum permitted value

Left front caster

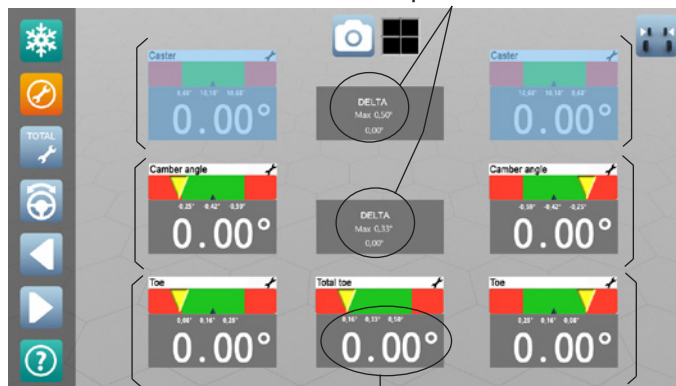

Right front caster

Left front camber

Right front camber

Left front toe-in

Right front toe-in

Total toe-in

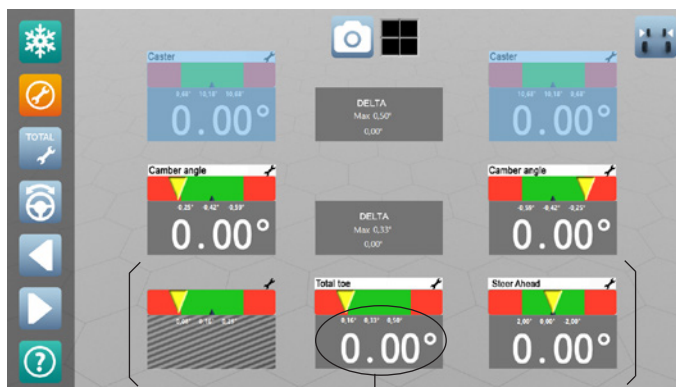

Steering angle

Total toe-in

The display of the partial toe-in allows adjusting the toe-in of vehicles equipped with a suspension system that allows adjusting the two wheels independently; this is true for most cars. Vice versa, the display of the total toe-in and the steering angle allows adjusting vehicles equipped with a total toe-in adjustment bar, which does not allow adjusting the two wheels independently; this is true for all trucks and some off-road vehicles.

Adjust in order the caster, camber and toe-in of the wheels until the indicator is in the green zone









For optimal adjustment follow the adjustment order: caster, camber, toe-in.

From the Front Adjustment page you can go to the Steering page.

It is advisable to repeat steering as a check if the caster is adjusted, since the caster measurement displayed on this page is necessarily an estimate.

If it is difficult to access the adjustment points, for example, because the vehicle is on the ground or the adjustment point is hidden by parts of the suspension, you can use the "freezing" procedure to adjust with the vehicle lifted or the wheels steered.

To make it easier to identify the adjustment points, use the adjustment help images.



-  : freezing  [9.7](#)
-  : displays the adjustment help images  [5.1](#)
-  : switches the display from partial toe-in to total toe-in
-  : goes back to the steering procedure  [Z](#)

► 9.4 - Adjusting the front toe-in with the vehicle resting on a support (toe-in curve - VAS procedure)

For vehicles for which the VAS procedure is required, when exiting the Rear Adjustment page, a message is displayed asking you to do some checks on the vehicle.



1. Check the vehicle conditions

- If they do not fall within one of the cases contemplated in the message, press  to go directly to the Front Adjustment page
- Otherwise press  to continue. The following appears:

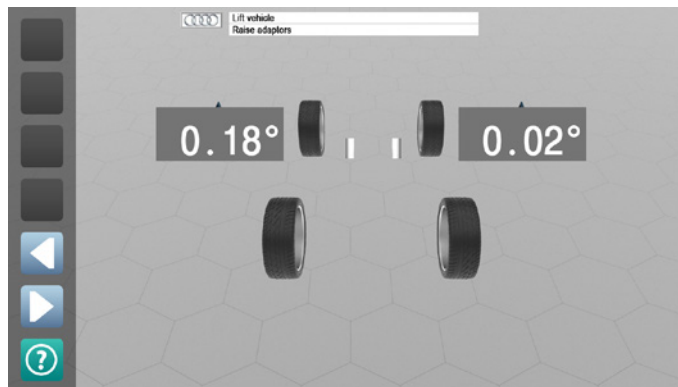

2. Lift the vehicle and position the VAS tool underneath the front axle
3. Move the adaptors into "raised" position and position the vehicle on them lowering it slowly
4. Press **F6**. The following appears:

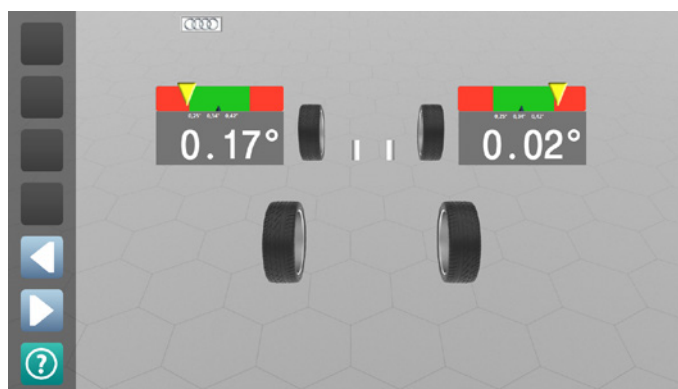

5. Adjust the toe-in by acting on the upper head
6. Press **F6** and the following appears:

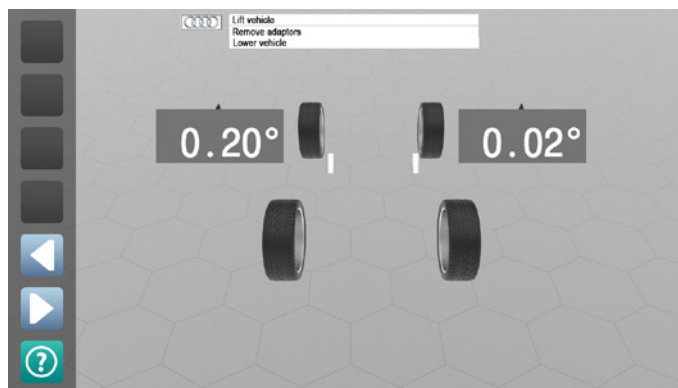

7. Lift the vehicle, remove the VAS tool, lower the vehicle and settle the suspension
8. Press **F6** to go to the Front Adjustment page.

► 9.5 - Adjusting with the wheels raised or steered (freezing)

If it is difficult to access the adjustment points, for example, because the vehicle is on the ground or the adjustment point is hidden by parts of the suspension, you can use the "freezing" procedure to adjust with the vehicle lifted or the wheels steered.



Freezing is particularly useful in the case of a 2-column car lift

The Freezing procedure consists of storing ("freezing") the measurements with the vehicle lowered and the wheels straight in order to keep them unaltered also after the vehicle has been lifted or the wheels steered. Thus you can adjust the angles to within the specified tolerances as if the vehicle were still lowered with the wheels straight.



This procedure can be activated on both the Front Adjustment and the Rear Adjustment page.

Starting from an adjustment page:

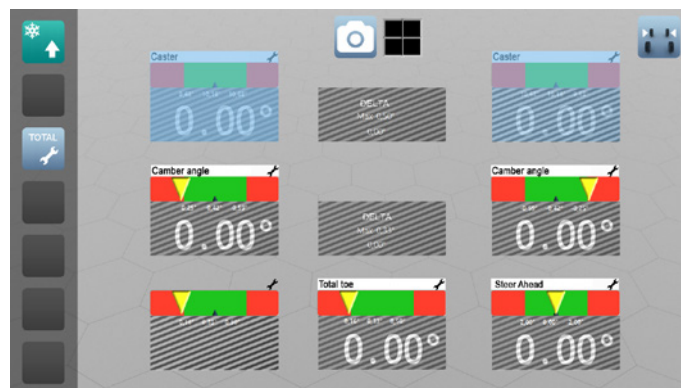
1. Press   to freeze the measurements. The graphics shows that the measurements have been frozen





2. Lift the vehicle or steer the wheels



3. Press   to unfreeze the measurements

4. Adjust the angles

5. If you are on the Rear Adjustment page and wish to do so, press  to go to the Front Adjustment page and adjust the front angles.

6. Press   to again freeze the measurements

7. Lower the vehicle or straighten the wheels













8. Press   to again unfreeze the measurements

If you go from the Rear Adjustment page to the Front Adjustment page with the vehicle lifted, for easier operation it is suggested to level the steering wheel and position the steering lock before lifting the vehicle.

10 - SUMMARY

Once you have completed the adjustments, the Summary page appears summarising the measurements before and after adjustment. From this page you can save or print the measurements; modify the customer informations; view the vehicle dimensions and enter the maximum steering measurements

MERCEDES-UE 190 E 2.3 16v Evolution 2 W 201 1985-1993											
Before adjusting				After adjusting							
Left	Right	Delta		Total toe	Left	Right	Delta				
	1°20			Partial toe	1°00	0°20					
1°00	0°20			Set-back	0°00						
2°30	2°50	0°20		Camber angle	2°30	2°50	0°20				
--	--			Caster	--	--					
--	--			SAI	--	--					
0°90	0°80	0°10		TOOT	0°90	0°80	0°10				
	0°70			Total toe	0°70						
1°00	-0°30			Partial toe	1°00	-0°30					
	0°34			Set-back	0°34						
2°00	1°90	0°100		Camber angle	2°00	1°90	0°100				
	0°05			Thrust angle	0°05						

-  : customer informations
-  : prints the results
-  : saves the results. They can be retrieved in the future from the Customer Databank page  [3.3](#)
-  : menu
 -  : target acquisition
 -  : steering  [Z](#)
 -  : vehicle dimensions  [10.1](#)
 -  : maximum steering  [7.3](#)

► **10.1 - Vehicle dimensions (only for High version)**

To access this page from the Summary page press **F4** and then **F3**.

The vehicle dimensions are useful to check the symmetry and identify any damage to the suspension system or the chassis.

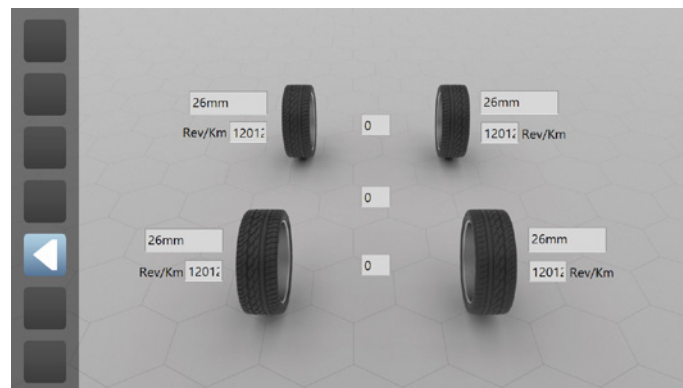
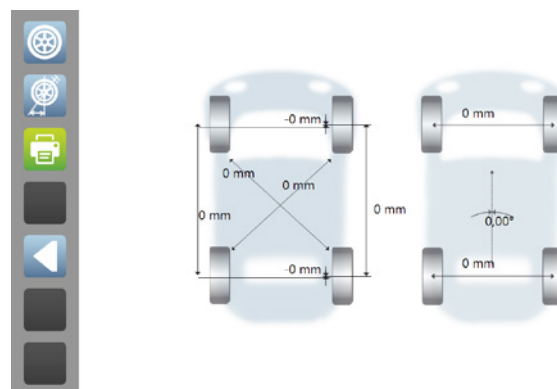
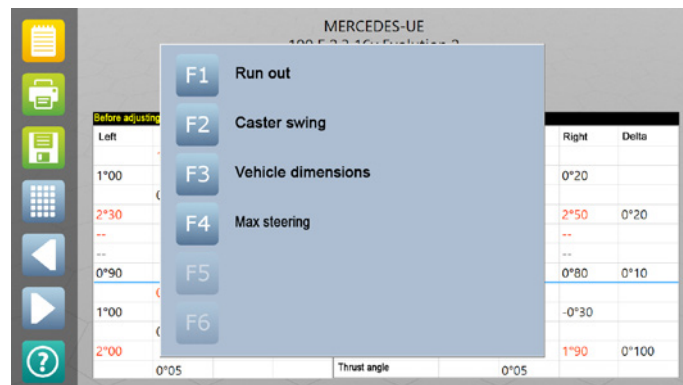

The page displays the thrust angles, axle deviation (set-back), wheelbase and track difference in value and in schematic form. These angles are displayed in degrees or in millimetres or inches according to the data available in the databank.

F1 : wheel dimensions

F2 : caster angle and friction range

F3 : printing