



RWA3D1090



OPERATION & MAINTENANCE MANUAL

IMPORTANT Any damage caused by failure to follow the instructions in this manual or improper machine use shall relieve the manufacturer of all liability.

SYMBOLS USED IN THE MANUAL



	SYMBOLS
	FORBIDDEN!
	Mandatory! Operations or jobs to be performed compulsorily
	Hazard! Be especially careful

TABLE OF CONTENTS

0.	WARNINGS	3
0.1.	Preliminary safety information	3
1.	INTENDED USE	4
2.	TRAINING OF DESIGNATED PERSONNEL	4
2.1.	General prevention measures	4
3.	EQUIPMENT COMPOSITION	5
3.1.	Cabinets of the Models R1090	5
3.2.	Management PC	6
3.3.	MEASURING HEADS	6
3.3.1.	<i>Measuring head keypads</i>	7
3.3.2.	<i>LED for indication of tolerance in</i>	7
3.4.	Clamps with target	8
3.5.	Turntables	8
3.5.1.	<i>Rotary plates STDA124 (for models R1090)</i>	9
3.6.	Push-pedal	9
3.7.	Steering lock	9
4.	EQUIPMENT CHARACTERISTICS	10
4.1.	Safety devices	10
4.2.	Precision measuring ranges	10
4.3.	4.3 Overall dimensions	10
5.	TRANSPORTATION AND INSTALLATION	11
5.1.	Transportation and unpacking	11
5.2.	Installation	11
5.2.1.	<i>Electrical connection</i>	11
5.2.2.	<i>Cabinet assembly</i>	11
5.2.3.	<i>Clamp / Target assembly</i>	12
5.2.4.	<i>Fixing of measuring head supports</i>	13
6.	SWITCHING THE EQUIPMENT ON AND OFF	15
6.1.	Switching on	15
6.2.	Switching off	15
7.	AUTOMATIC SWITCHING OFF OF THE MEASURING HEADS	16
8.	LOW BATTERY INDICATION	16
9.	PROGRAM CONFIGURATION	17
9.1.	DATABASE Groups Configuration	18
9.2.	Miscellaneous	20

10.	DIAGNOSIS AND ADJUSTMENT OF A VEHICLE	22
10.1.	Presentation page	22
10.2.	Preliminary operations	23
10.2.1.	Preliminary vehicle control operations	23
10.2.2.	Preparing for measurements	23
10.3.	Selecting the make and model of a vehicle	25
10.4.	Display of prechosen vehicle technical data	27
10.4.1.	Display of ADDITIONAL MEASUREMENTS on RIDE HEIGHTS	28
10.4.2.	Display of CHECK MEASUREMENTS on RIDE HEIGHTS	29
10.4.3.	Display of images for AID in ADJUSTING	30
10.5.	Push run-out with automatic acquisition	31
10.6.	Preparing for measurements	33
10.7.	Aligning of the vehicle / direct measurements	34
10.8.	Steering procedure	35
10.9.	Vehicle diagnoses	36
10.10.	Preparation for adjustment	36
10.11.	Rear axle adjustment	37
10.12.	Front axle adjustment	38
10.12.1.	Front toe in adjustment with steered wheels	39
10.12.2.	"Jack-Hold" Procedure	40
10.13.	Summary of the ADJUSTMENT DIAGNOSIS data	41
10.13.1.	"Test Drive" procedure - steering wheel alignment check	42
10.14.	Auxiliary functions menu	43
10.14.1.	Chassis diagnosis	44
10.15.	Printing of measurements taken	45
10.16.	Saving of tests performed with TEq-Link	49
10.16.1.	TEq-Link functionality configuration	49
11.	DATABASE CUSTOMISATION	50
11.1.	Insertion of a new group	50
11.2.	Deletion of a new group	51
11.3.	Insertion of a new vehicle	52
11.4.	Deletion of a customised vehicle	53
12.	SMARTCARD FOR PROGRAM AND DATABASE PROTECTION	54
12.1.	DATABASE management	54
13.	ERRORS DURING MEASURING	55
13.1.	Measuring heads data transmission / receiving error / target non-identification errors target identification.	55
14.	PROBLEMS	56
15.	MAINTENANCE	56
16.	STORAGE AND SCRAPPING	57
17.	MACHINE IDENTIFICATION DATA	57

0. WARNINGS

Any damage resulting from failure to observe the instructions contained in this manual and from improper use of the machine exempts Rotary from any responsibility.

0.1. Preliminary safety information



Before turning on the equipment:

- Read the instructions and the entire manual before using or working on the wheel aligner. This manual is an integral part of the product and is intended to provide the user with instructions on the use of the RWA3D1090 wheel aligner. Therefore, keep it, for the entire operating life of the machine, in a known and easily accessible place and consult it whenever uncertainties arise. All product operators must be able to read the manual.
- Check that the power supply complies with the specifications shown on the plate. The plate with the voltage and frequency data is located on the back of the equipment. Please note the information on the plate. NEVER connect the appliance to a voltage or frequency other than those indicated.
- Properly arrange the power cable of the wheel aligner. This product has a built-in 3-wire plug with grounding. It only fits into a socket with built in grounding. If it is not possible to insert the plug into a socket of this type, please consult an electrician. Do not modify or misuse the plug.

When the equipment is turned off:

- Do not turn off the PC, contained within the equipment, by unplugging or using the switch of the PC itself, but use the procedure described see para. 6.2 on p. 15 Incorrect shutdown of the PC can cause "corruption" of the files contained in the HARD-DISK.
- The shutdown procedure described see para. 6.2 on p. 15 does not intervene on the supports for recharging the batteries, which therefore continue to be powered.

In emergency conditions and before any maintenance work:

- Isolate the machine from power sources, with the appropriate main switch of the machine and remove the plug from the power socket.
- Do not try to maintain this unit arbitrarily, as opening or removal of the doors could expose you to dangerous voltages; maintenance interventions must only and exclusively be carried out by authorised service personnel.

Work environment and equipment cleaning:

- The work environment must be kept clean, dry, not exposed to atmospheric agents and sufficiently lit.
- Avoid cleaning the equipment with jets of water and compressed air.
- To clean plastic panels or shelves, use a damp cloth (in any case avoid liquids containing solvents).

Rotary may at any time make changes to the models described in this manual for technical or commercial reasons.

The trademarks **TEq-Link** is owned by Rotary
All the remaining trademarks mentioned, the reproduced logos and the images belong to the legitimate owners who fully hold the relevant rights.



1. INTENDED USE

The RWA3D1090 system is an equipment intended for detection of all the characteristic angles of vehicles. Two-axle cars and light commercial vehicles can be tested with wheelbase between min 1800mm and max 4700mm. Detection of the angles is carried out by two sensors positioned between the front and rear wheels, each with two Megapixel cameras that identify the position in space of 4 three-dimensional targets positioned on the wheels.

The data transmission from the sensors to the cabinet takes place VIA RADIO through compatible modules Bluetooth.

The operation range of the equipment is the below:

Temperature : from 0 °C to 40 °C - Pollution degree - Class 3 - Overvoltage category - CAT II - Maximum Elevation level - 3000 m above sea level (asl)

2. TRAINING OF DESIGNATED PERSONNEL

Only specially trained and authorised personnel may use the equipment. In order to ensure machine management are optimal and for measurements to be carried out efficiently, the designated personnel must be properly trained to learn the necessary information in order to achieve an operating mode that is in line with the instructions provided by the manufacturer. For any uncertainties relating to use and maintenance of the machine, consult the instruction manual of the machine or individual equipment (PC, monitor, printer ...); if in doubt, do not interpret, it is advisable to consult the authorised service centres or the Rotary technical assistance directly.

2.1. General prevention measures



- During operation and maintenance of this machine, it is absolutely essential to comply with all the safety and accident-prevention regulations in force.



- The equipment must be used only by authorised and adequately trained personnel.



- It is not allowed to store very heavy objects (weighing more than 15Kg) in the compartments inside the cabinet, such as turntables.



- This equipment must only be employed for the use for which it is expressly designed. Rotary declines all responsibility for damage to persons, animals and property caused by improper use of the machine.



- The installation of accessories and spare parts must be performed by authorised Rotary personnel and original accessories and spare parts must be used. It is also not allowed, in any way, to replace the batteries using non-original, it is necessary to use only the manufacturer's original battery on the heads.



- The machine must only work in places where there is no danger of explosion or fire.



- The removal or modification of safety devices or of warning signs placed on the machine can cause serious danger and constitutes a violation of the OSHA safety standards.



- Before carrying out any maintenance on the system, it is necessary to disconnect the power supply. If in doubt, do not interpret, contact the Rotary technical assistance in advance in order to receive information to be able to perform operations in conditions of maximum safety.



- Prevent authorized personnel from approaching the wheel aligner during use.



- The operator should wear safety footwear to prevent foot damage, caused by accidental fall of clamps or measuring heads. Use footwear with certified protection according to the rule EN ISO 20345 standard.

3. EQUIPMENT COMPOSITION

3.1. Cabinets of the Models RWA3D1090

LEDs that indicate the charging phase of the batteries

BATTERY CHARGER SUPPORT
(the mod. HPR includes a set of extra STDA160 batteries)

MONITOR
There is a 32"16/9 high definition colour monitor
The instructions on use and maintenance are shown in the manual supplied with the same; follow the instructions indicated in it.

USB Wi-Fi adapter

Wireless mouse and mat (HPR model only)

MANAGEMENT PC HOUSING
Accessible from the rear panel. For the characteristics of the PC see para. 3.4 on p. 8

POWER SUPPLY OUTLET
Equipment GENERAL SWITCH (on the rear panel)

CENTRAL COMPARTMENT FOR PRINTER HOUSING
The results are printed with a colour inkjet printer for A4 size sheets. The instructions on the use and maintenance of the printer are provided in the manual supplied with the printer; follow the instructions indicated in it.

MEASURING CABINET
The measuring cabinet is used for all the measurement operations. The cabinet is equipped with electronic components for processing and managing of the measurements received from the sensors.
Power supply: 220/240 Vac single-phase 50/60Hz
Max absorbed power: 500w

4 supports for housing of the clamps with target

To remove the batteries, press the internal side of the battery charging support from below

3.2. Management PC

The software product is installed on the management PC (personal computer), located inside the cabinet. The management PC has the following minimum features:

- Processor 2.00 GHz
- RAM 4 Gb;
- Smart card reader
- 6 USB; 1 LAN Ethernet 10/100/1000 Mb;
- Integrated Windows 10 IoT™ operating system, standard operating system in English
- Screen output 1366x768 Pixels HD Ready
- Hard Disk ≥ 64.0 Gb

3.3. MEASURING HEADS

The measuring heads of the 3D equipment do not require the connection of any cables or cords for measuring angles or for data transmission.

The detection groups consist of 2 megapixel cameras for each measuring head. Each camera has a group of high efficiency infra-red emitting LEDs, which act as illuminators for the 3D targets positioned on the wheels of the vehicle.

The measuring heads communicate directly with the cabinet. Data transmission takes place VIA RADIO through compatible modules Bluetooth contained within the heads and cabinet.

The characteristic angles of both vehicle axles are controlled and compensated by 2 side cameras and 2 electronic inclinometers positioned inside the two measuring heads.

Power is supplied by long-lasting 12V rechargeable batteries. The batteries are recharged when they are inserted in the charging support located on the cabinet (see para. 3).

Note: together with the measuring heads package, there is a leaflet cod. 2025R37800 with warnings on battery use and maintenance.

ATTENTION: When the battery is removed and/or inserted, always turn off the measuring head; it can be turned off manually by simultaneously pressing the external red and green buttons (see para. 3.3.1. on p. 7).

The power and consumption data of the measuring heads with rechargeable battery is the following

Power supply	NiMH battery (Nickel-Metal Hydride) 12V- 4Ah
Average operation with battery in full efficiency and charged	Approximately 8 hours
Average charging time	Approximately 12 hours



Figure 1

3.3.1. Measuring head keypads

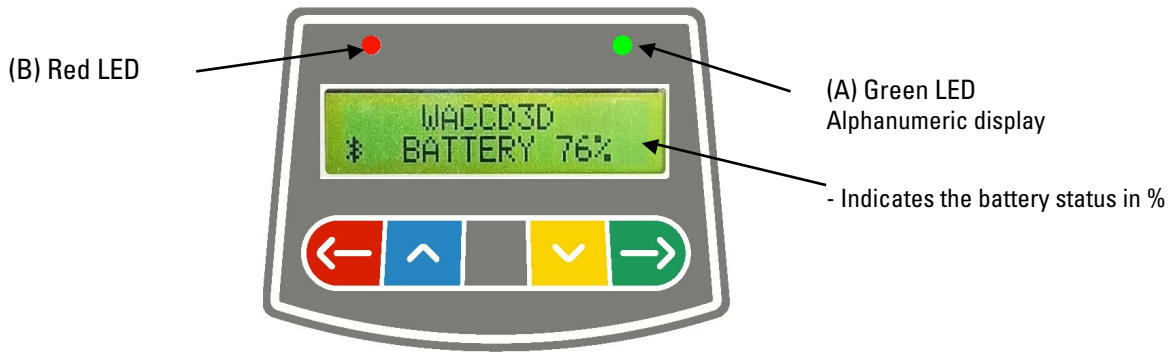

Figure 2

KEYS		DESCRIPTION
		Head ignition key.
		Pressed simultaneously they manually switch off the head.

Key of Figure 2:

- A - • Green LED: Not used.
- B - • Red LED on steady: The measuring head is on
 • Red LED flashing (fast): The measuring head is turning on
 • Red LED flashing (slow): The measuring head battery is low (when the remaining battery charge is lower than or equal to 30%); it will turn off after a few minutes

3.3.2. LED for indication of tolerance in adjusting

The measuring heads are equipped with side-mounted red/green LED indicators.

During the detection phases of the angles, these are simply switched on intermittently, to indicate the operation of the measuring devices.

For the RWA3D1090 series, during the adjustment phase do they report the values in tolerance.

Tolerance indicator during adjustment

- GREEN LED flashing → the measurement is in tolerance exactly in the centre
- RED LED flashing together with the GREEN LED steady → the measurement is within tolerance
- RED LED on → the measurement is NOT in tolerance

NOTE: The toe tolerance is always indicated on the lower LED row.

During rear adjustment, the camber is always indicated on the upper row of LEDs

During the front adjustment, both the camber and the caster can be indicated on the upper LED row. The "R" selection symbol is required on the desired value (see para. 10.13 on p. 41).

LED on the FRONT SIDE		CAMBER/CASTER tolerance (bring the "R" selection symbol to the desired angle) TOE Tolerance
LED on the REAR SIDE		CAMBER Tolerance TOE Tolerance

3.4. Clamps with target

They are all of the self-centring type, including removable claws.
3-point self-centering holding clamps, complete with target (for rims from 8" to 24").



They are marked Front Left and Right and Rear Left and Right, according to the following table (See Figure 4):

- FL = FRONT LEFT
- FR = FRONT RIGHT
- RL = REAR LEFT
- RR = REAR RIGHT

Attention: the inclination of the targets is determined at the time of installation, as described see para. 5.2.3 on p. 12
Once the target has been mounted, during the procedure, it is only advisable to fix the clamps taking care to position them approximately vertically (see figures above).

Each target also has a barcode that describes the characterisation of the 3D object in space.

The clamp + target and production progressive calibration for traceability are also contained in the afore-mentioned code.

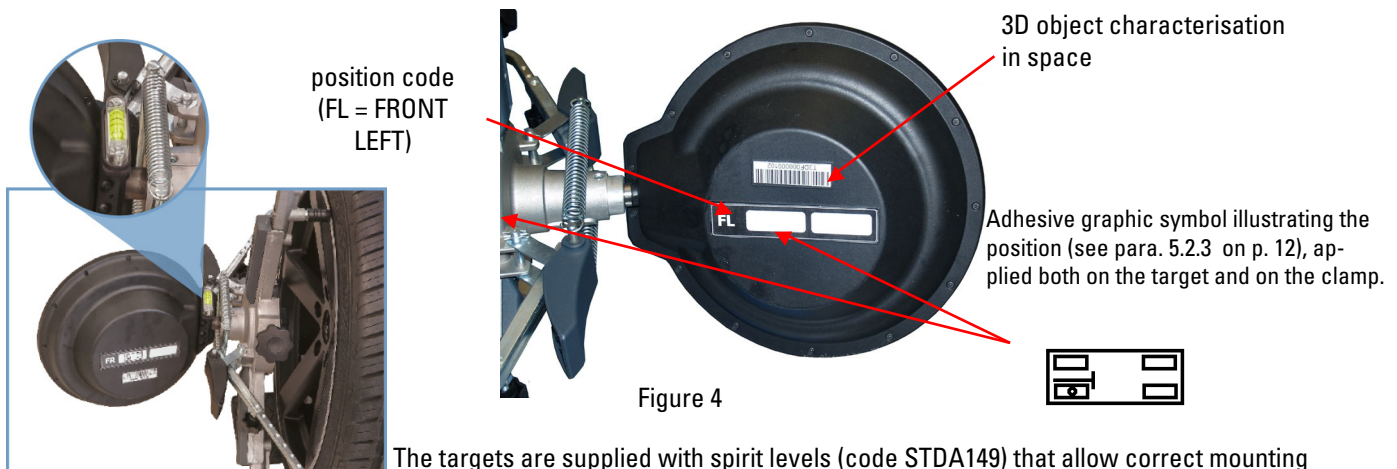

The targets are supplied with spirit levels (code STDA149) that allow correct mounting of the clamps with precise and simple orientation of the target.

3.5. Turn plates

3.5.1. Turn plates STDA124

The STDA124 turn plates have a plate with a 360 mm diameter.

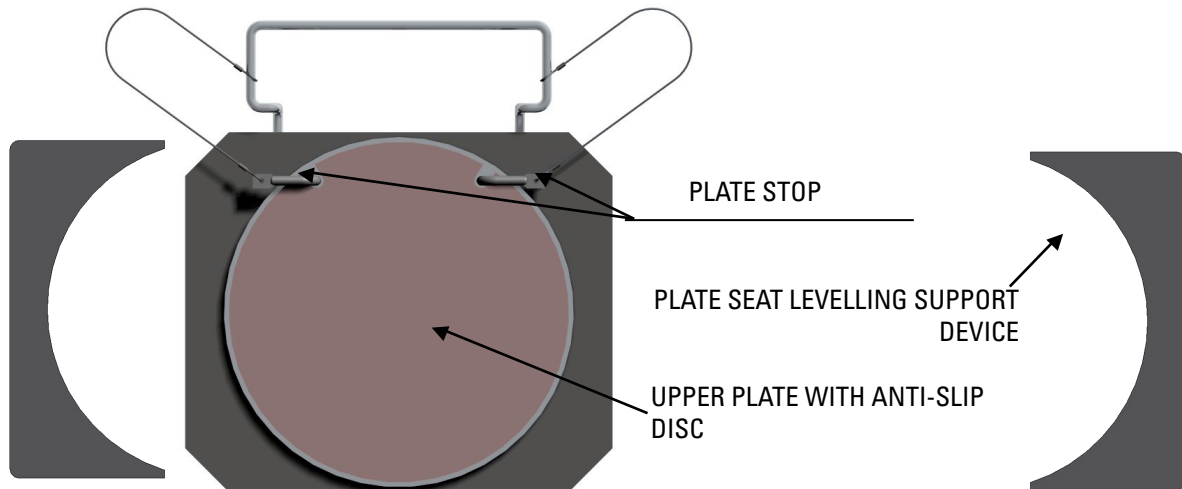

3.6. Push-pedal

It is a tool used to lock the brake pedal during measurement preliminary operations. It is to be used as shown in the instructions that appear during the program.



3.7. Steering lock

It is a tool used to hold the steering in a fixed position. It is used before the adjustment procedure as shown in the instructions that appear during the program.



4. EQUIPMENT CHARACTERISTICS

4.1. Safety devices

The wheel aligner is equipped with a safety device (main switch) located on the rear of the machine, see para. 3 on p. 5. The main switch deactivates the power supply of the machine when placed in the "0" position.

4.2. Precision measuring ranges

Axis	Measurement	Precision	Measuring range	Total measuring range
Front	Toe	± 2'	± 2°	± 20° x 2
	Partial Toe	± 1'	± 1°	± 20°
	Set-back	± 2	± 2°	± 5°
	Camber	± 2'	± 3°	± 10°
	Castor	± 5'	± 10°	± 18°
	KPI/SAI	± 5'	± 10°	± 18°
Rear	Toe	± 2'	± 2°	± 20° x 2
	Partial Toe	± 1'	± 1°	± 20°
	Set-back	± 2'	± 2°	± 5°
	Camber	± 2'	± 3°	± 10°
	Trust angle	± 2'	± 2°	± 5°

4.3. Overall dimensions

RWA3D1090

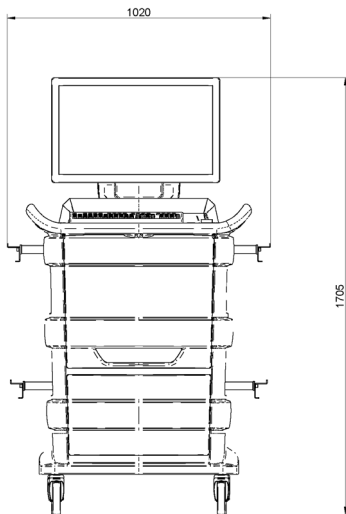

Figure 5

5. TRANSPORT AND INSTALLATION



5.1. Transport and unpacking

The machine is supplied packed in a box secured onto a pallet to facilitate transportation. To transport the machine to the point where it will be installed, use lifting and transport means such as forklifts or lift equipped with forks.

The machines must be stored packed in a dry and ventilated place (permitted temperature -25° + 55°C).

The packaging must never be overturned or arranged horizontally, the pallet must always rest on a flat and solid surface, do not stack other packages on top, the arrangement must allow easy reading of the indications.

DURING UNPACKING ALWAYS WEAR GLOVES TO AVOID POSSIBLE INJURIES CAUSED BY CONTACT WITH THE PACKAGING MATERIAL (NAILS, ETC.).

Be sure to have received all the standard parts listed above.

The packaging material (plastic bags, polystyrene, nails, screws, wood, etc.) must be collected and disposed of according to the regulations in force, with the exception of the pallet, which could be reused for subsequent handling of the machine.

5.2. Installation

Install the machine in a dry, covered, sufficiently lit place, possibly enclosed or in any case protected from atmospheric agents. Before positioning the equipment, make sure that the chosen location is suitable for the regulations in force on workplace safety and check the minimum distances from walls or other obstacles.

5.2.1. Electrical connection

Before connecting the machine, check carefully:

- that the characteristics of the power line correspond to the requirements of the machine indicated on the relative plate;
- that the grounding line is present and that it is adequately sized (section greater than or equal to the maximum section of the power cables);
- that all the components of the power line are in a good condition;

Connect the machine to the mains using the supplied 3-pole plug (230V single-phase) to the socket on the wall. If the plug supplied is not suitable for the one on the wall, equip the machine with the plug in accordance with the local laws and current standards and regulations. This operation must be performed by experienced and qualified personnel.

5.2.2. Cabinet assembly

The assembly of the cabinet of the RWA3D1090, consists of fixing the monitor and positioning the PC and printer in their housing (see para. 3 on p. 5).

5.2.3. Clamp / Target assembly

The targets must be mounted on the clamps and oriented at approximately 20°. To perform this with precision, use the procedure described below .

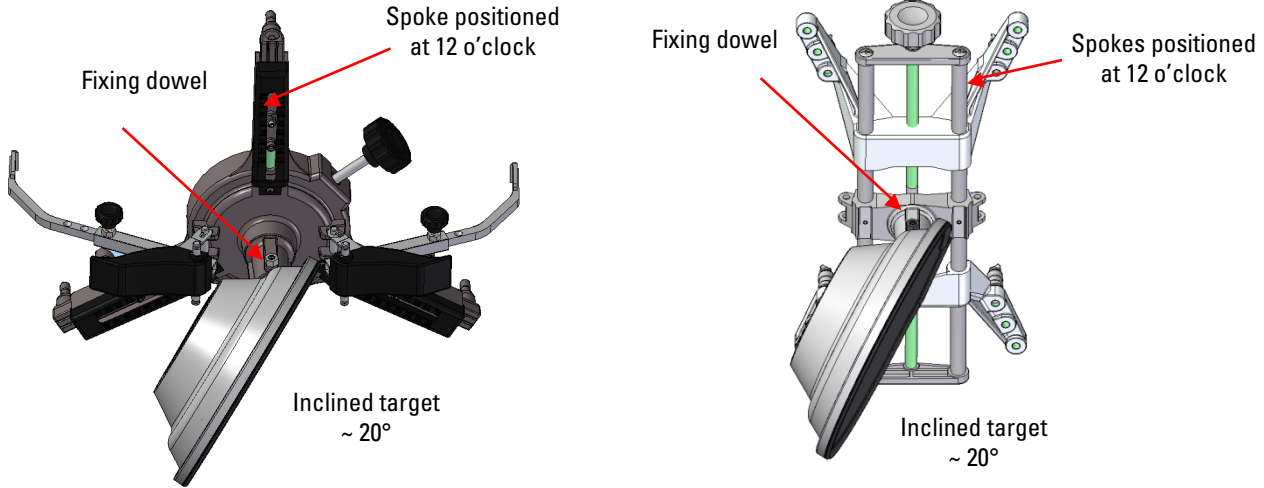

Mount the targets on the clamps oriented approximately 20°, as shown above, and place them all on a vehicle.

N.B. Be sure to mount the clamps with the spokes strictly vertical (12 o'clock), as in the figure above.

Select the "target mounting" option in the "Configuration" menu item.

As soon as the targets are attached and optimised, the screen shown in the figure below appears.

Carefully orient the 4 targets by aligning the arrow with the target positioned above. If one or more targets are not correctly oriented, the symbol "X" appears (see example in the rear right clamp).

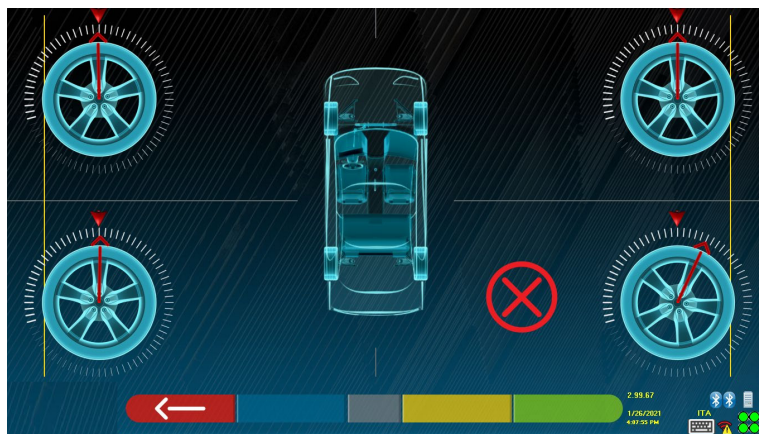

Figure 6



Apply the two stickers provided for each clamp/target group, identifying the front left (FL), front right (FR), rear left (RL) and rear right (RR) positions.

See Figura 4 on page 8

5.2.4. Fixing of measuring head supports

It is necessary to drill 3 holes for M8 screws on each side of the lift, in order to fix the supports of the measuring heads, making sure that the distance from the centre of the heads to the centre of the turn plates is 1150 mm. If it is necessary to measure vehicles with a very long wheelbase, it is possible to move the plates forward by a further 400 mm. The maximum distance from the rear wheels to the centre of the heads is 3150 mm.

Note: Be sure to drill holes at a distance of 1150mm on both sides of the lift.

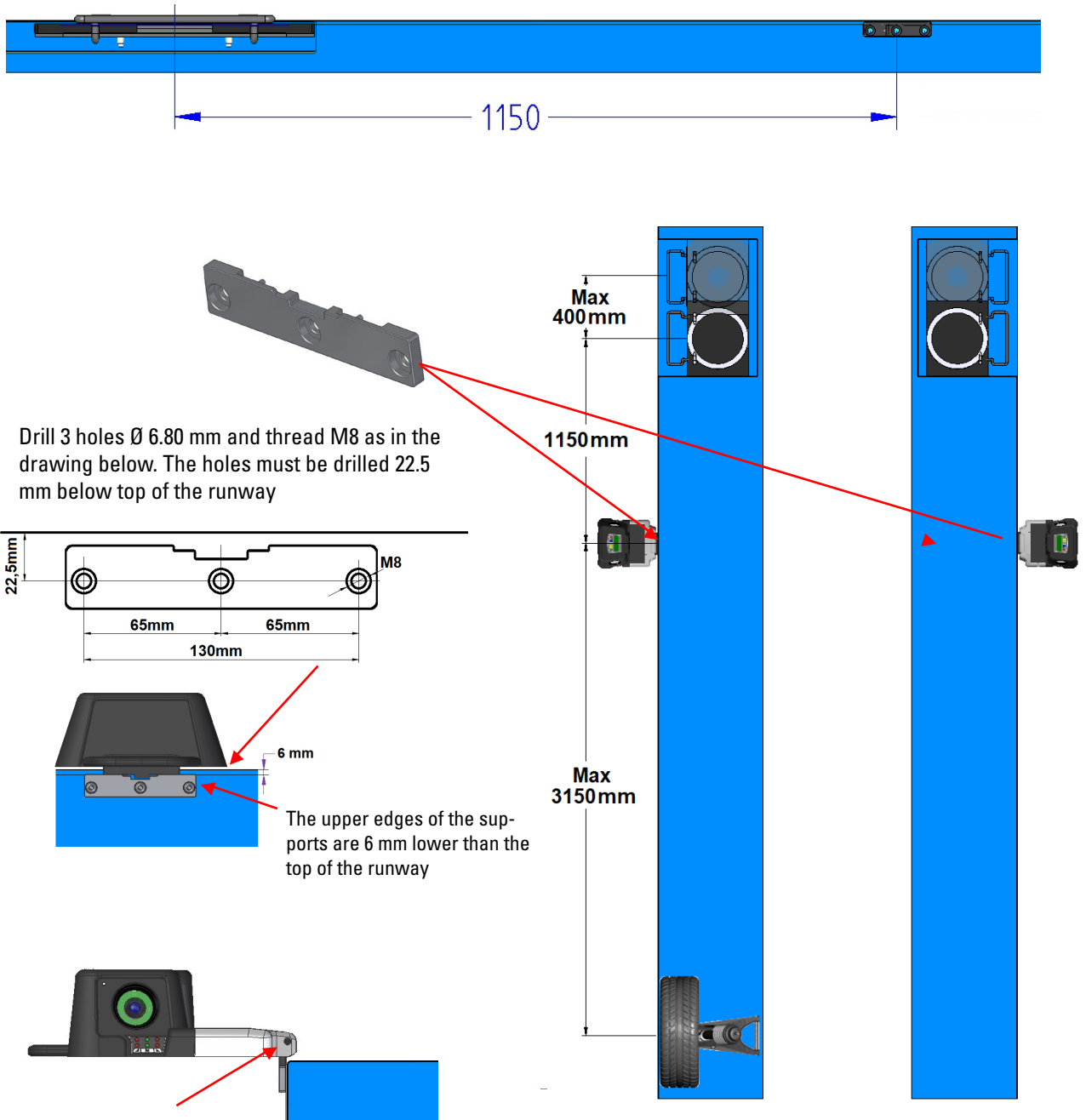
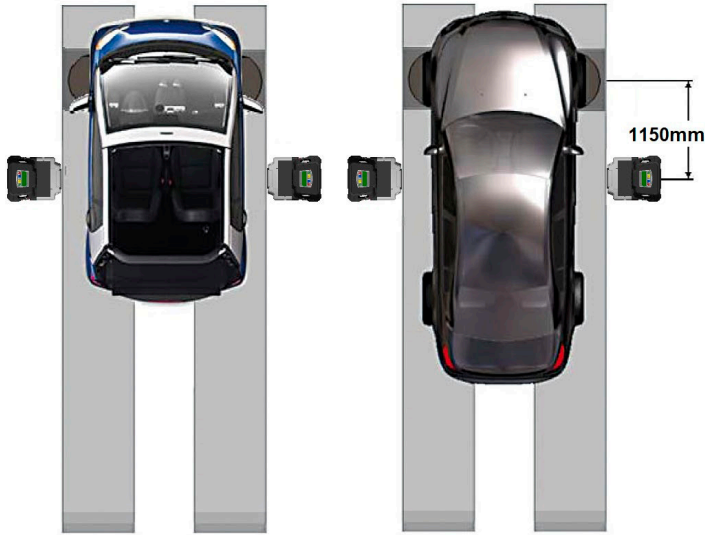
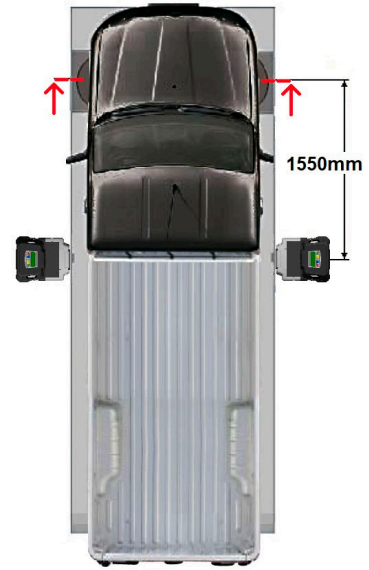

Figure 7

The 3D system can measure cars and vans with two axles and with pitches from 1800 mm to 4700 mm; and with track between 1200 mm and 2600 mm



For vehicles with small and medium wheelbase, place the turn plates at normal distance from the head (distance between heads / front target 1150 mm)



For very long wheelbase vehicles: Position the turn plates away from the head (distance between heads / front target 1550 mm)

6. SWITCHING THE EQUIPMENT ON AND OFF



ATTENTION: Before turning the equipment on, make sure that the SMART CARD for enabling of the program and of the database is inserted in the appropriate reader on the front of the PC. see para. 12 on p. 54

6.1. Switching on

To turn the equipment on and to be able to access the program, it is necessary to use the dedicated switch located on the back of the unit.

At the end of the PC initialization process, using the Windows operating system, the program is automatically activated and the presentation page is displayed on the monitor from here it is possible to activate all the functions of the equipment (see para. 10 on p. 21).

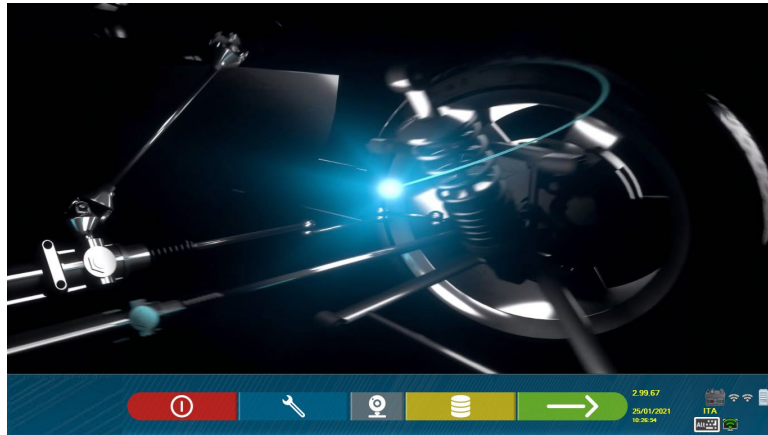

Figure 8

6.2. Switching off

From the presentation page (see para. 10 on p. 22) it is possible to turn off the equipment by selecting the appropriate button.

	SENSOR KEYPAD	PC KEYPAD	DESCRIPTION
			Activates the switching off procedure of the equipment

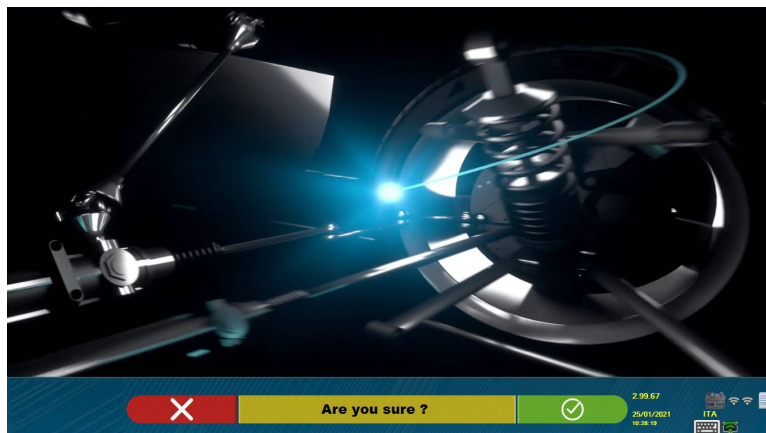







Figure 9

	SENSOR KEYPAD	PC KEYPAD	DESCRIPTION
			Deletes. Returns to the presentation page. (see para. 10 on p. 21)
			Definitive confirmation of switch off of the equipment

Then turn off the equipment using the switch located on the back.



ATTENTION: The shutdown procedure does not affect the supports for recharging of the batteries, which therefore continue to be powered.

7. AUTOMATIC SWITCHING OFF OF THE MEASURING HEADS

The system makes sure that the measuring heads turn off when the PC is turned off from the presentation page. However, the measuring heads switch off automatically after approximately 5 min. if they do not receive data (e.g. the cabinet is off).

However, they can always be switched off manually (see para. 3.3.1. on p. 7) when they are not being used.

8. LOW BATTERY INDICATION

The system displays a low battery warning (Figure 10).

This signal is also given on the sensor itself with flashing of the red power LED (see para. 3.3.1. on p. 9).

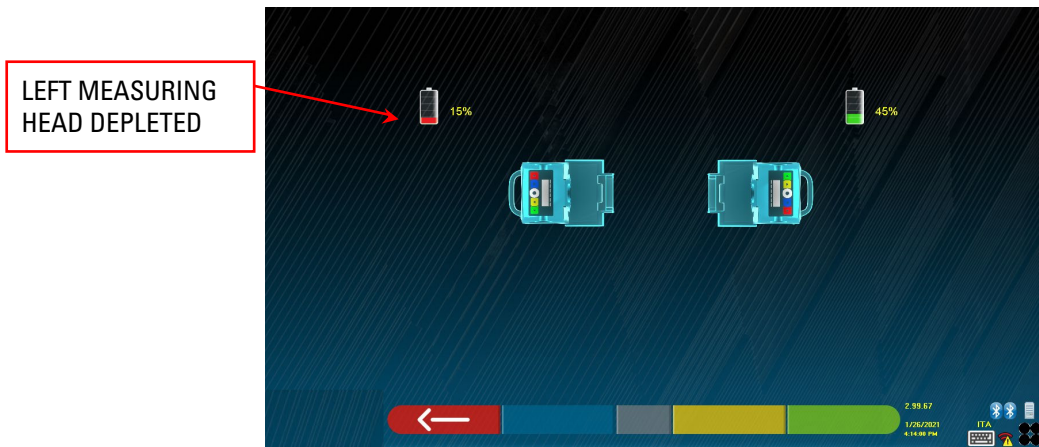



Figure 10

When the residual charge is LOWER OR EQUAL to 30%; the program displays the low battery warning page (Figure 10). The head will turn off after a few minutes. Avoid this situation by always placing the batteries in charge as soon as possible.

To exit the error report page, press the F1 key .

9. PROGRAM CONFIGURATION

To be able to configure the program, select the F2  key on the presentation page, as explained see para. 10.1 on p. 22.

A configuration menu is accessed that can be used to change the characteristics of the program according to requirements.

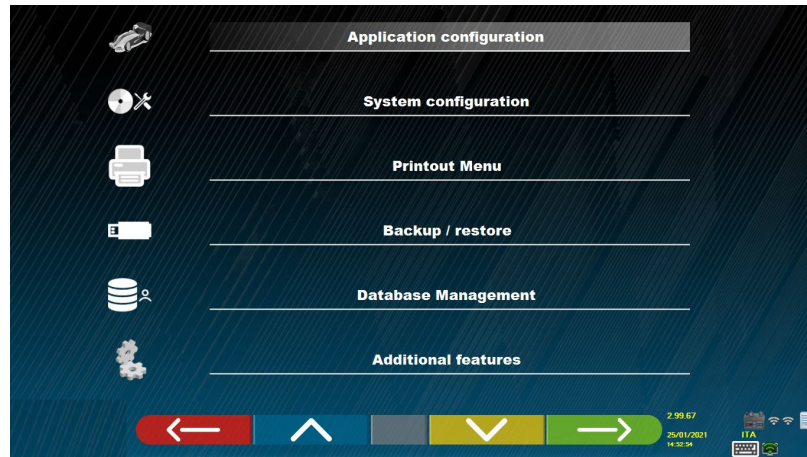

Figure 11

Application Configuration: It is possible to select the language from those available; it is possible to configure the association of events such as run-out, steering, adjustment with "beep" sounds to facilitate the user in the procedure (see para. 10.12 on p. 38); it is possible to configure the "Teqlink" function (see para. 10.16.1 on p. 49).

Configuration: the program displays the screen shown in - Figure 14 -

It is possible to change the system parameters, the database profile, to specify which components are present in the equipment and what type they are and to carry out the Bluetooth search for coupling of the sensor to the cabinet.

Prints Menu: It is possible to customise the print by entering the data for the workshop, to choose the type of print required and to select the default printer (if there are more than one connected).













Backup / Restore: In order not to risk losing the vehicle and customer database data, it is advisable to create a backup copy (save). A "flash disk" USB key is used for this operation.

It is possible to recover lost or deleted data, if the backup operation was performed, with the restore procedure.

Database Management, see para. 12 on p. 54

Additional functions: the program displays the screen from where it is possible to access the TEST or sensor calibration applications (reserved for specialist and authorised personnel)

9.1. DATABASE Groups Configuration

	SENSOR KEYPAD	PC KEYPAD	DESCRIPTION
			Returns to the presentation page. (see para. 10.1 on p. 22)
			Moves the selection up.
			Moves the selection down.
			Confirms the selection.

Select the "CONFIGURE GROUPS" option in the program configuration page as explained in see para. 9 on p. 17. It is possible to change the system parameters, the database profile and to specify which components are present in the equipment and what type they are. Choose the "DATABASE" option and confirm. The screen that appears next is the following:

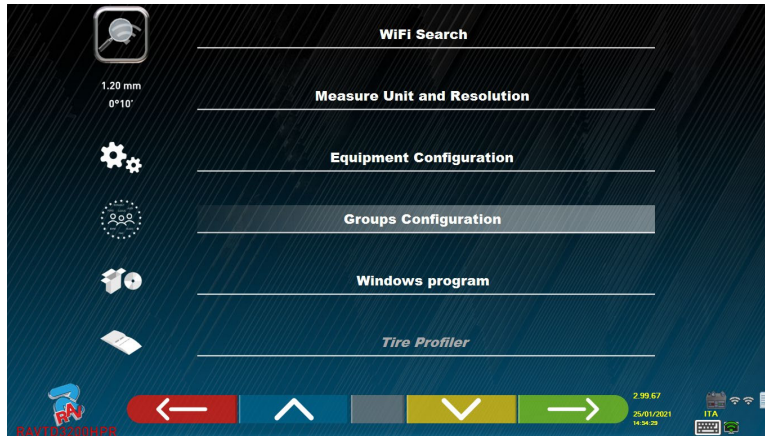

Figure 12

	SENSOR KEYPAD	PC KEYPAD	DESCRIPTION
			It returns to the initial configuration page. (see para. 10.1 on p. 22)
			Moves the selection up.
			Moves the selection down.
			Confirms the selection.

The page of Figure 13 displays a list, with the various profiles of the DATABASE, containing the MAKES of vehicles

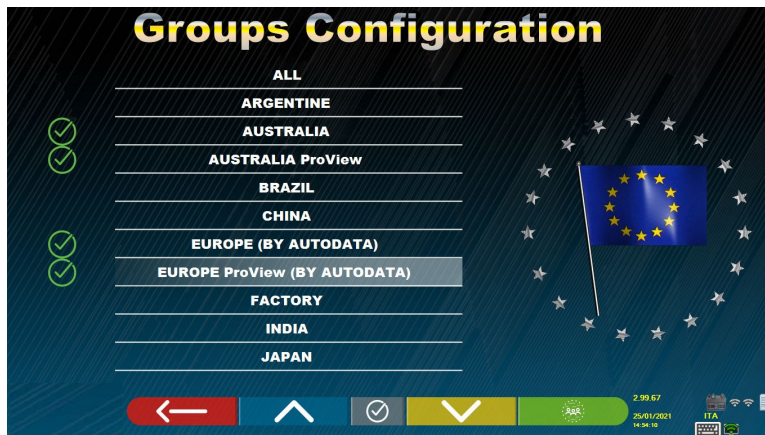

















Figure 13

	SENSOR KEYPAD	PC KEYPAD	DESCRIPTION
			It returns to Figure 12
			Moves the selection up.
			It hides/displays the various profiles of the Database.
			It moves the selection down, displaying the next profiles.
			Confirms the selection.

in circulation in different countries or regions of the world.

It is possible to hide and/or display, using the F5 key , any profile in order to manage the

Database according to requirements.

By selecting any group and pressing F4 it is  also possible to customise the profile hiding and/or dis-

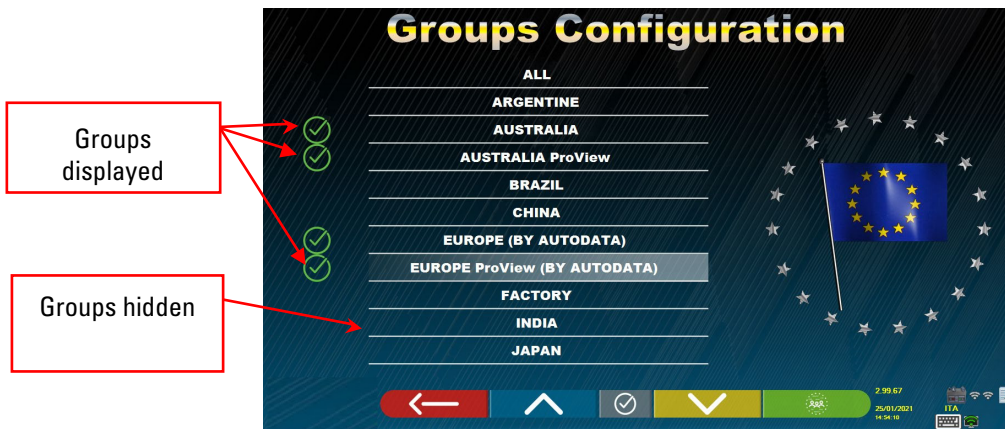



Figure 14

playing the makes present, with the F5 key 

9.2. Miscellaneous

Select "Additional Features" from the menu configuration page, as explained see

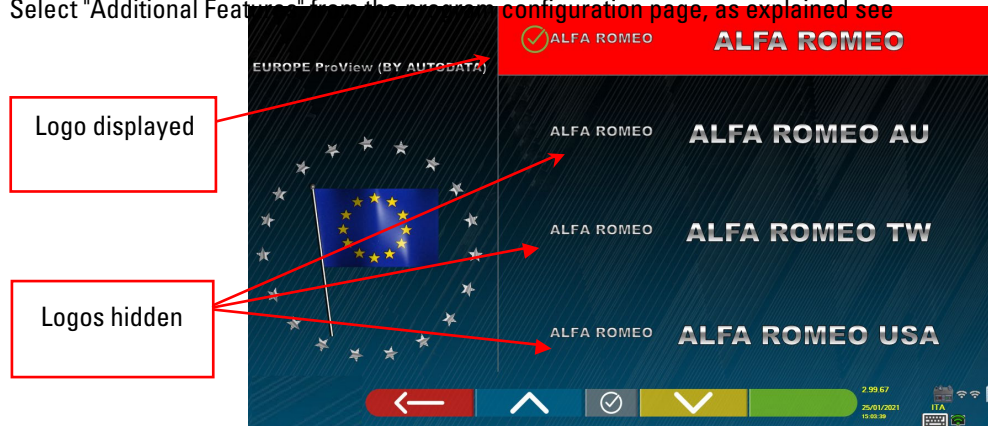

Figure 15

para. 9 on p. 17. Then select "Miscellaneous". It is possible to find 3 "Miscellaneous" options where there are various selections to customise particular set-up procedures.

There is also the "Plate recognition function" option, only for some countries and only if it has been enabled by the manufacturer. In "Miscellaneous 1" it is possible to set: the automatic switch-off function of the F1 key on the home page. It is also possible to enable adjustment on Fast Check, to skip the run-out procedure, videos, steering and to choose the type of database search. It is possible to set the Standard or "Quickcheck" QC4 or QC2 procedure mode.

In "Miscellaneous 2" it is possible to enable and/or disable certain functions such as Set Back live, CASTER/KPI adjust-

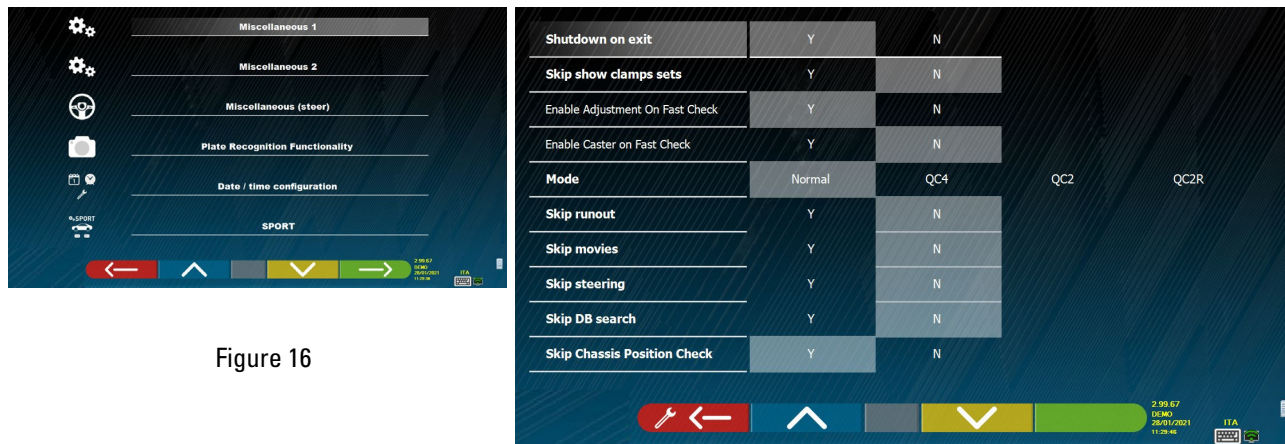

Figure 16

ment, to set the average value for the ride height and to set the functions of the "Test Drive" and the display of the diagnosis summary.

The options for setting of the steering procedures are available in "Miscellaneous Steering" (start from the left or right side, choose the left or right driving side, single or automatic steering mode).

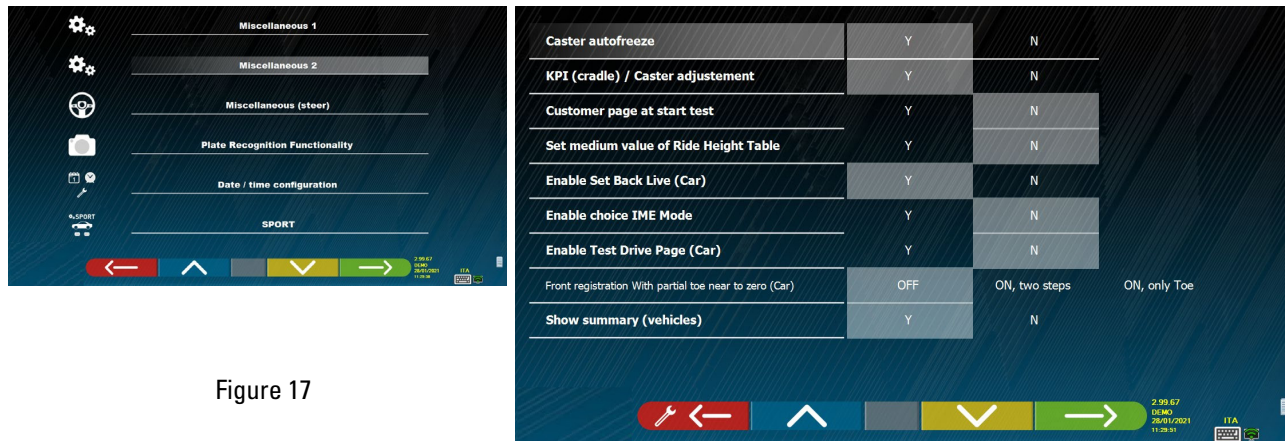

Figure 17

In "Plate Recognition Functionality" (N.B. this menu option is only available if the manufacturer has granted the authorization for their country, relating to their Smartcard, see para. 12 on p. 54) it is possible to enable this option

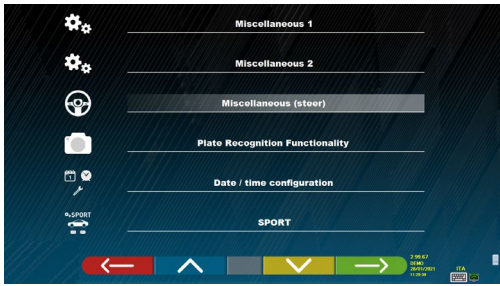
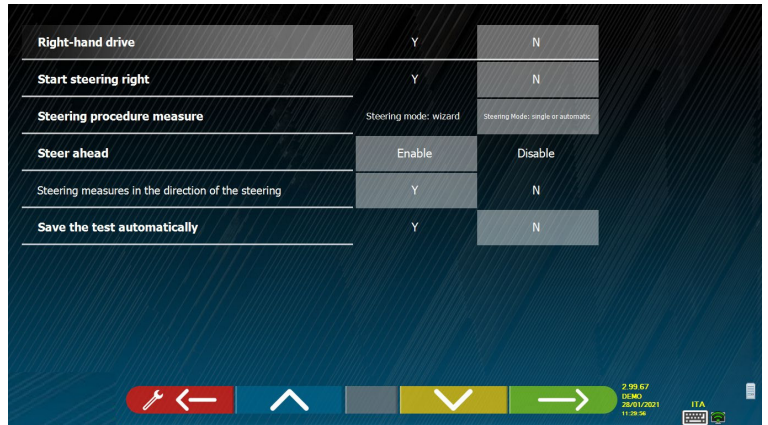



Figure 18



To exit the page, press the F1 key  .

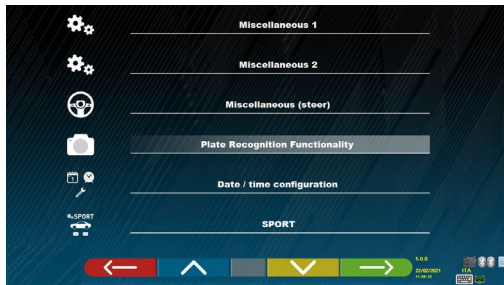
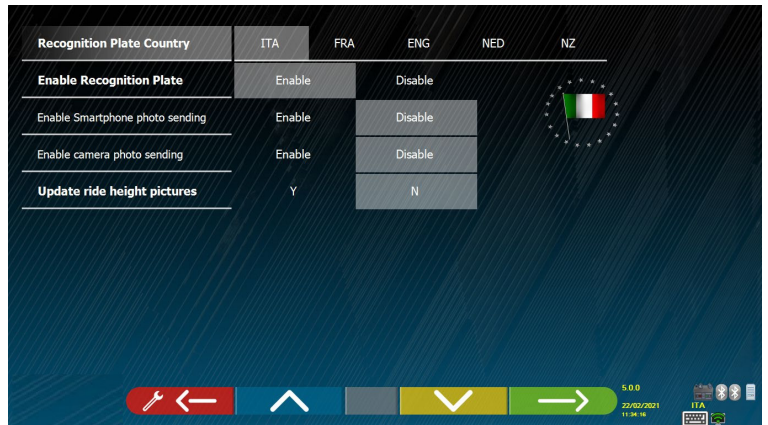

Figure 19



10. DIAGNOSIS AND ADJUSTMENT OF A VEHICLE

10.1. Presentation page

When the equipment is switched on (see para. 6.1 on p. 15), the initial screen of the program appears, from where it is possible to select various functions.

10.2. Preliminary operations

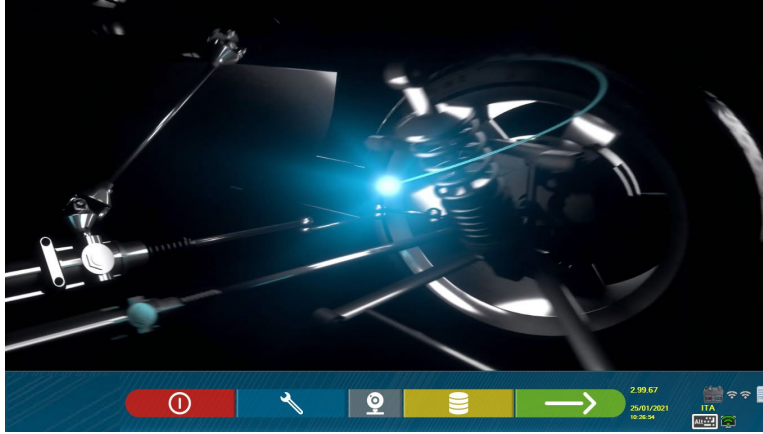

Figure 20

	DETECTOR KEYPAD	PC KEYPAD	DESCRIPTION
			Turns off the equipment (see para. 6.2 on p. 15)
			Program configuration (see para. 9 on p. 17)
			Accesses the customer database of the saved tests
			Selects the list with the various data-base profiles (see para. 9.1 on p. 17)

Press key F4 to continue.

10.2.1. Preliminary vehicle control operations

Before starting to check the geometric set-up of a vehicle, the following checks must be carried out:

- Check and possible eliminate any gaps on suspensions and on the steering linkage
- Check and if necessary eliminate possible hardening or yielding of the elastic parts of the suspensions.
- Adjust the tire pressure to the values prescribed by the manufacturer.
- Position and distribute any loads foreseen by the manufacturer.

10.2.2. Preparing for measurements

Before proceeding and selecting the vehicle technical data page (see para. 10.4 on p. 27), the vehicle can be prepared for measurement as follows:

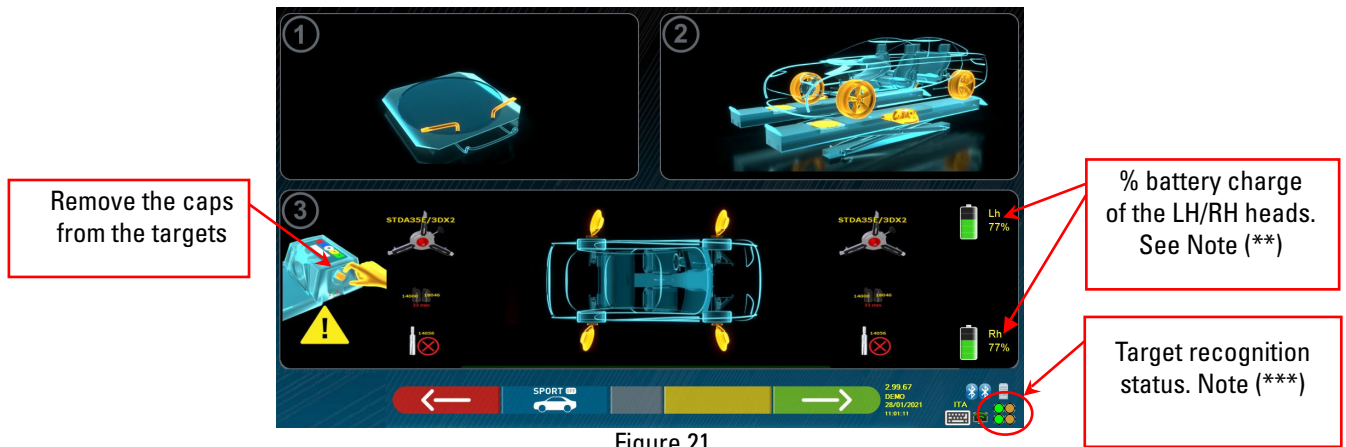
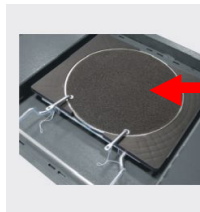

Figure 21

	SENSOR KEYPAD	PC KEYPAD	DESCRIPTION
			Returns to the previous page
			PORT" procedure for super sports cars (with side spoilers that can prevent reciprocal measurements between the heads). With this program the measurements between the heads are acquired before the vehicle is on the lifter, and are then used later.
			Continued on the next page (Make and Model Selection) (see para. 10.3 on p. 24)

- Prepare for measurements by locking the turn plates and all the rear oscillating platforms
- Position the vehicle on the lift correctly, with the front wheels on the rotary plates







- Attach and switch on (*) the 2 measuring heads on the edges of the runway (see Figure 1) Mount the clamps with the four targets on the wheels, positioning the upper arm at 12 o'clock



(*) It is convenient to mount the clamps with the targets and switch on the 2 measuring heads already in this preliminary phase, to allow the system to recognise and "connect" the 4 targets positioned on the wheels. The time that elapses in the subsequent phases of make and model selection and display of technical data is consequently used by the system also for the recognition and optimisation of the 4 targets.

(**) In this phase, images are displayed representing the 2 batteries of the measuring heads with the relative% of residual charge.

(***) The system takes a few seconds to complete correct recognition of the targets; during this phase, and in the subsequent ones in which measurements are carried out, symbols appear in the lower right part of the screen that represent the progress of the recognition of the 4 targets. See legend below.

-  = Target NOT recognized (GREY symbol)
-  = Target recognized and being optimised (GREY symbol)
-  = Target recognized and optimised / invalid measurements (YELLOW symbol)
-  = Target recognized and optimised / valid measurements (GREEN symbol)
-  = Target not required at this stage (BLACK symbol)

ALWAYS be careful to position the vehicle centered on the runway, it must be as centered as possible, in order to speed up and optimise the search and engagement of targets and subsequent measurements.

10.3. Selecting the make and model of a vehicle

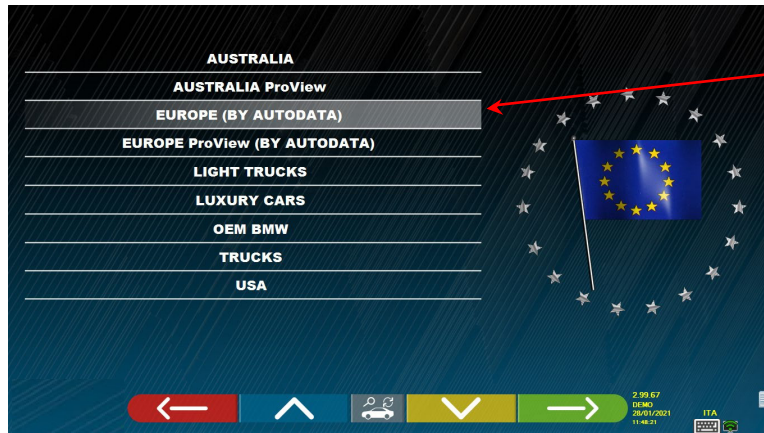

List with the different profiles of the data base (see para. 9.1 on p. 17)

Figure 22

Press the F4 key  to select a vehicle make and model. The program shows the list of makes of the selected group (see Figure 24)

Or press the F5 key  to search using the keys (model / make /

year) or through the V.I.N (Vehicle Identification Number) which is a unique serial number used by the automotive industry to identify motor vehicles. The V.I.N. consists of a plate with 17 alphanumeric characters usually located inside the engine compartment. See Figure 23. This search only works with the USA Database (STDA110U)

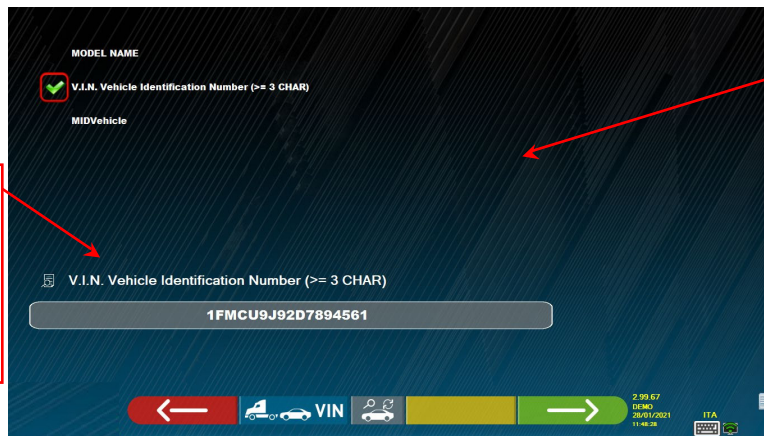

Note: the search mode is selected using the F5 key : Through search keys model make name/year or VIN (Figure 23) or through manual selection (Figure 24).



Enter the V.I.N. here (Search working with USA database – STDA110U)

Enter the model (max 3 words of at least 3 characters). It is also convenient to enter the make. It is also possible to enter the year of production (4 digits required)

Figure 23

Press the key  to move the cursor from entering "model name" to entering "VIN". Press the key  to continue and display the list of all the vehicles that meet the search criteria introduced above, then select the correct vehicle and display the page of the technical data of the chosen vehicle (see para. 10.4 on p. 27)

In order to select the make and model of a vehicle, press the key  on the presentation page (Figure 20) or on the database profiles page (Figure 22). The program displays the following page:

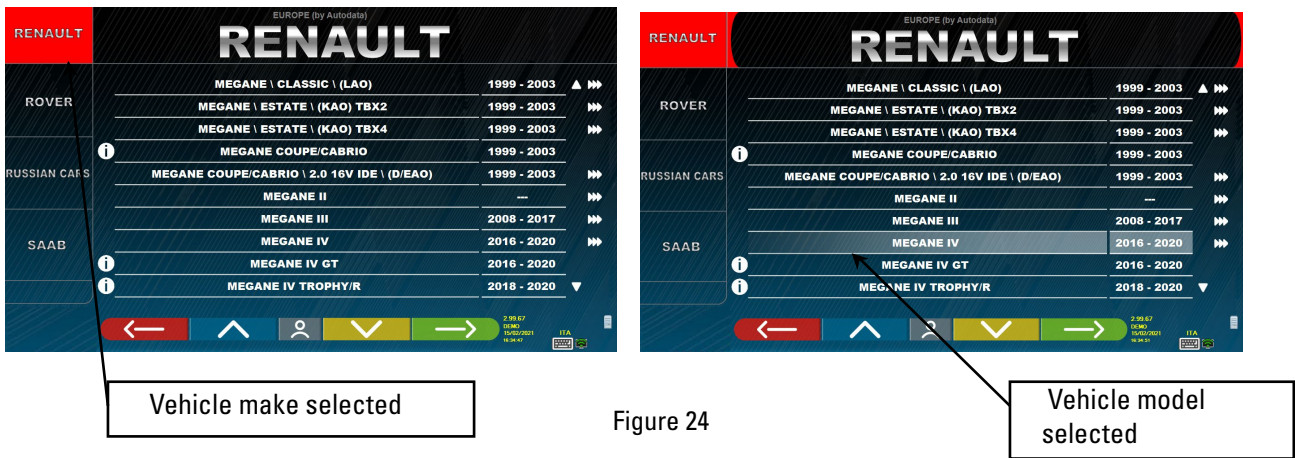





















Figure 24

It is necessary to select the make and model of the vehicle on which to operate.

	SENSOR KEYPAD	PC KEYPAD	DESCRIPTION
			Returns to the presentation page (see para. 10.1 on p. 22)
			Moves the selection up.
			Moves the selection down.
			Confirms the selection and continues to the next phase
			Sets the order: alphabetical or date order (ascending or descending)
			Moves the selection up by one page.
			Moves the selection down by one page.
			Moves the selection to the start of the list.
			Moves the selection to the end of the list.

NOTE: To speed up the selection operation, it is possible to press on the PC keypad the name of the make or model being sought, or part of the name and then scroll through the list until finding the one that is required.

10.4. Display of selected vehicle technical data

When a vehicle is chosen (see para. 10.3 on p. 25), a screen appears with the measurements and tolerances that the manufacturer has provided.

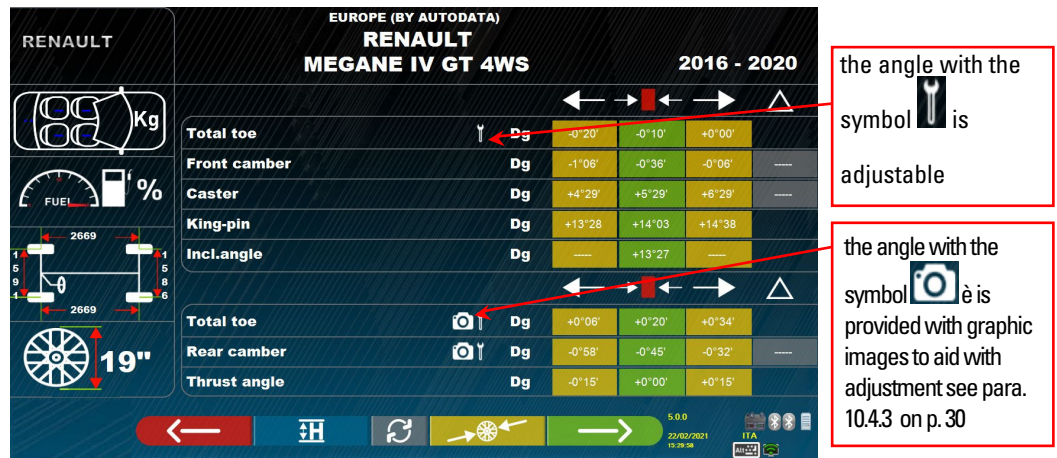

















Figure 25

	SENSOR KEYPAD	PC KEYPAD	DESCRIPTION
			Returns to the vehicle selection (see para. 10.3 on p. 24)
			Possibility to enter data of ride height or inclination, as provided by the manufacturer (see para. 10.4.1 on p. 28 and see para. 10.4.2 on p. 29)
			Displays the next page of the vehicle technical data
			Varies the rim diameter value
			Continues with the Run-out operations (see para. 10.6 on p. 33)

Press the key  to confirm the choice of the vehicle and proceed to the next phase (Run-out compensation procedure - see para. 10.5 on p. 1)

10.4.1. Display of ADDITIONAL MEASUREMENTS on RIDE HEIGHTS

manufacturers (e.g. Mercedes, Renault) provide angle tolerance values according to particular measurements on the vehicle chassis. When the selected vehicle has angle tolerance values connected

to additional measurements on the chassis, the technical data page (Figure 26) will feature the key 

Press the F2 key  to view the page with the details of the measurements on the chassis.

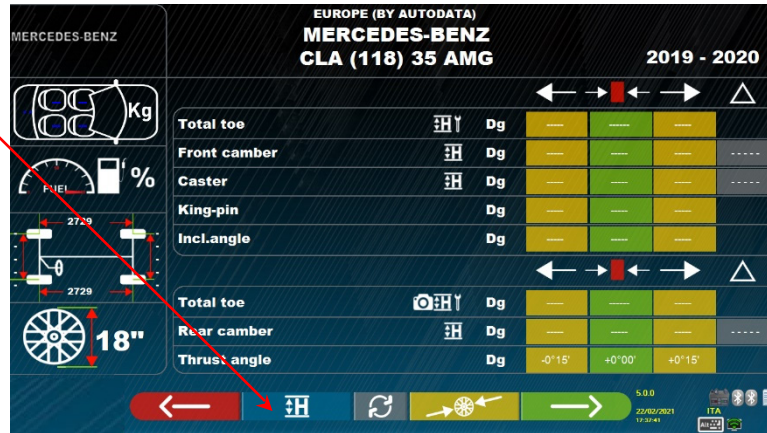



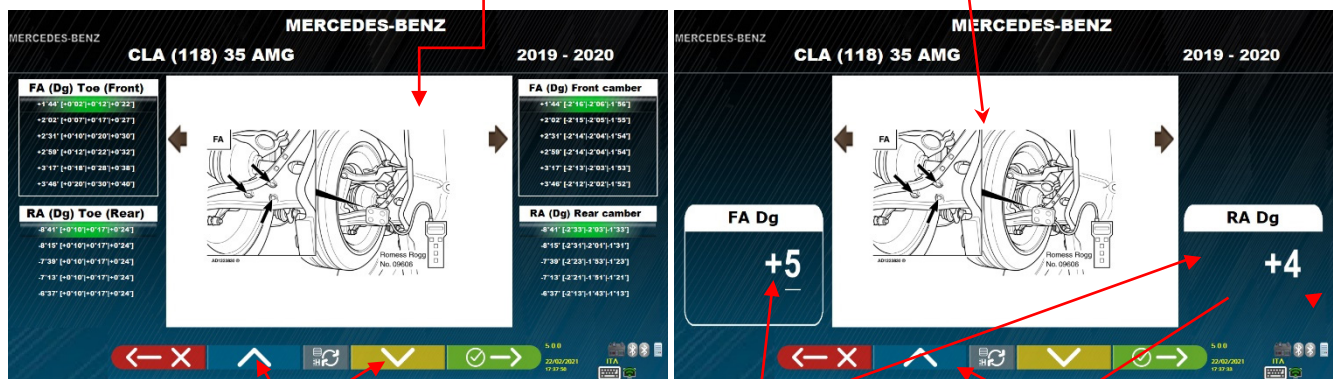



Figure 26

By pressing the key  the program will display a page like the example in Figure 27, where the measurements required by the manufacturer must be entered.

The measurements can be entered by selecting them from the tables, as in the example on the left, or it is possible to directly enter the values as in the example on the right; to change the entry mode press the key 

the help images in the centre can be scrolled through using the keys  / 



Use the keys  /  to select the correct value in the tables

Use the key  to confirm

enter the values directly



Use the keys  /  to select the correct value in the tables

Figure 27

Press the F4 key  to confirm the entered values.

10.4.2. Display of CHECK MEASUREMENTS on RIDE HEIGHTS

Some manufacturers (e.g. Citroen, Peugeot) provide tolerance values referring to particular measurements on the vehicle chassis (control values).

When the selected vehicle has tolerance values with control values, the technical data page (Figure 28) includes the key

. Press the key to display the page with the details of the control values.

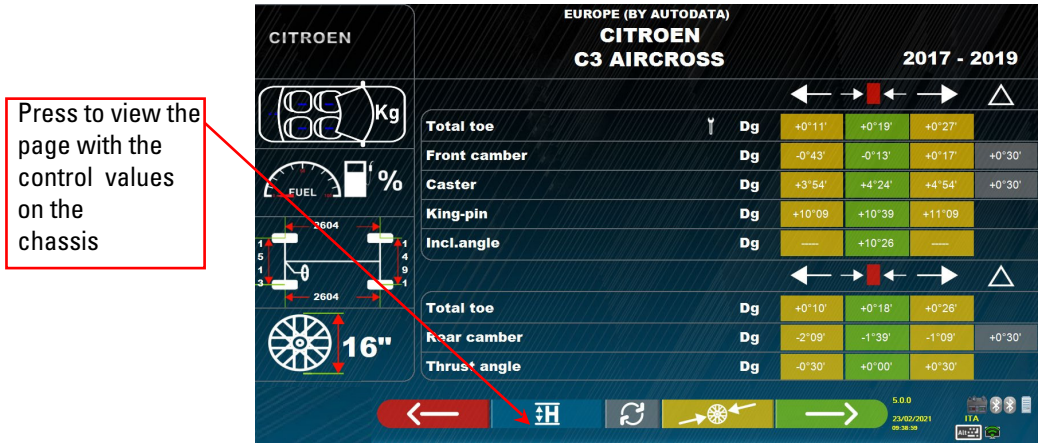

Figure 28

The program displays a page as in the example of Figure 29, press F9 to enlarge the image.

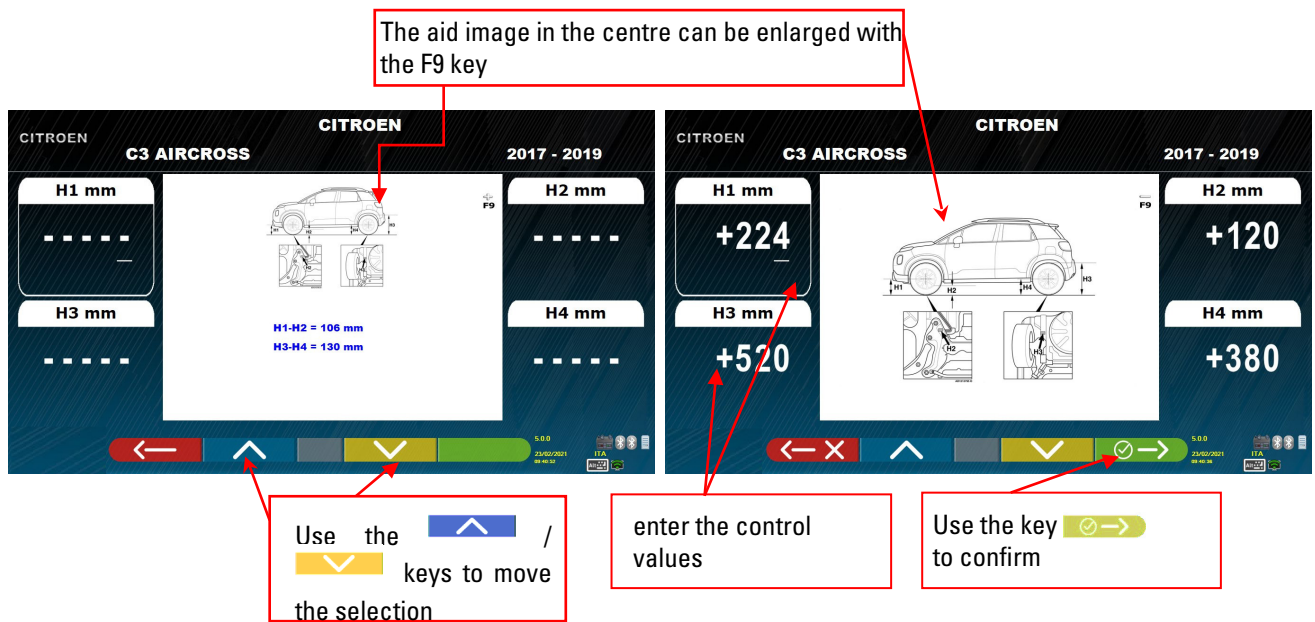



Figure 29

Enter the control values, and press the F4 key  to confirm the entered values.

10.4.3. Display of images for AID in ADJUSTMENT

For various vehicles of some manufacturers, images are available to assist in adjustment, which indicate the adjustment modes on the various angles of the vehicle, such as the camber and caster of the front axle or the camber and toe of the rear axle.

When the selected vehicle has assistive images for adjustment, on the technical data page (Figure 30) there is a symbol  next to the angle indication.

Press the **ALT+F3** "  " keys to view these images

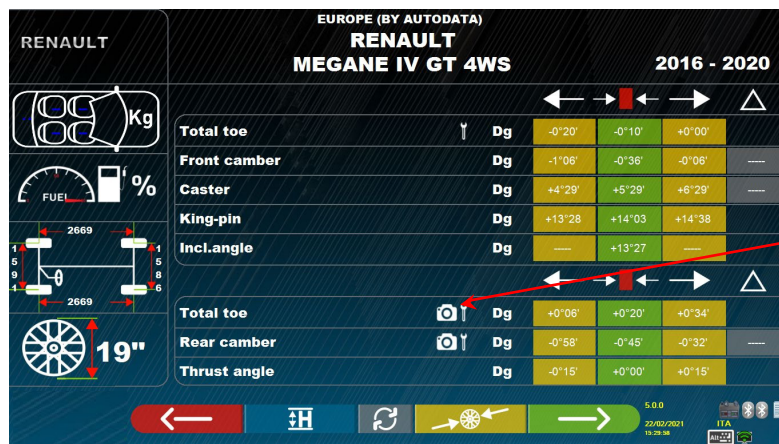



the angle with the symbol  is provided with graphic images for aid upon adjustment

Figure 30

The program displays a page as in the example of Figure 31, use the F2 key  to view the various enlarged images.

press the key  to select the available adjustment aid images

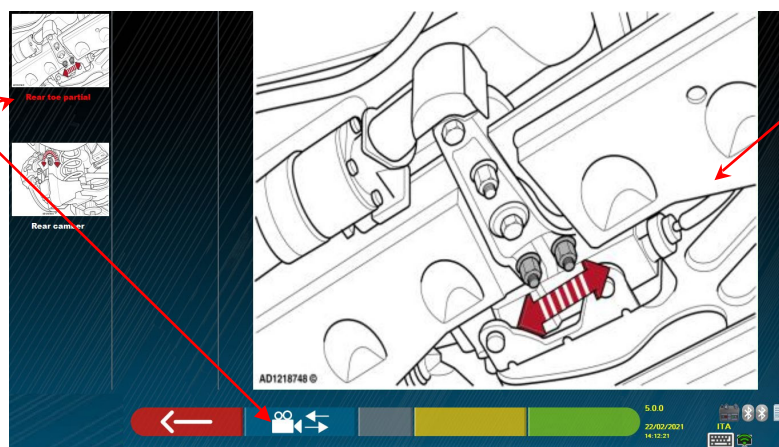

Selected enlarged adjustment aid image

Figure 31

Press the key  to return to the vehicle technical data page.

Note: also during the later adjustment phase (see para. 10.11 on p. 37), if there are images for adjustment aid, an F1 key

 is available, to be able to view them if necessary.

10.5. Push run-out with automatic acquisition

The run-out procedure is useful to compensate for any inaccuracy of the rims and clamps.

You can decide not to perform the procedure, simply press the F4 key.

It is possible to activate this procedure even after running the vehicle diagnostics, by selecting the dedicated option in the menu (see chap. 10.15 - Preliminary operations).

In order to carry out the run-out procedure, it is necessary to have performed the preparation as explained see para. 10.2.2 on p. 23.

It is necessary to mount the brackets by positioning the vertical spoke at approximately 12 o'clock, so that by performing the run-out the targets always remain correctly visible to the cameras. If one or more positions are not acceptable, the error screen shown below appears, showing for example an incorrectly positioned rear right clamp. Simply position the "12 o'clock" clamp, the program proceeds automatically.

By pressing F1 instead, the error is not considered. In the case of run-out, it may not be possible to complete the procedure.

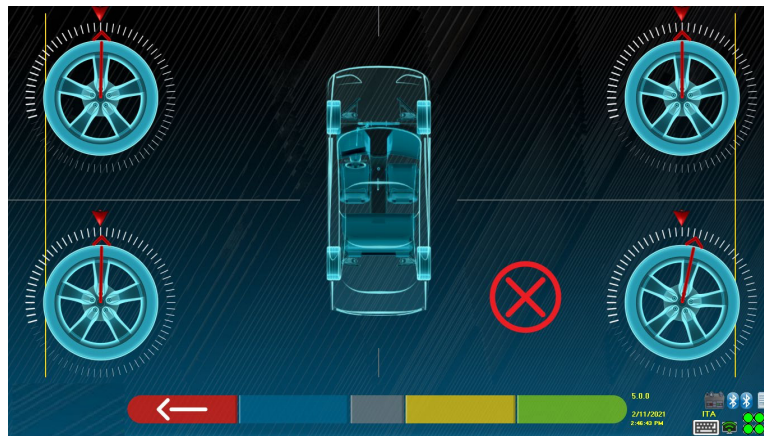

Figure 32

Press the F4 key



from the technical data display phase (see para. 10.4 on p. 27).

The following screen appears:

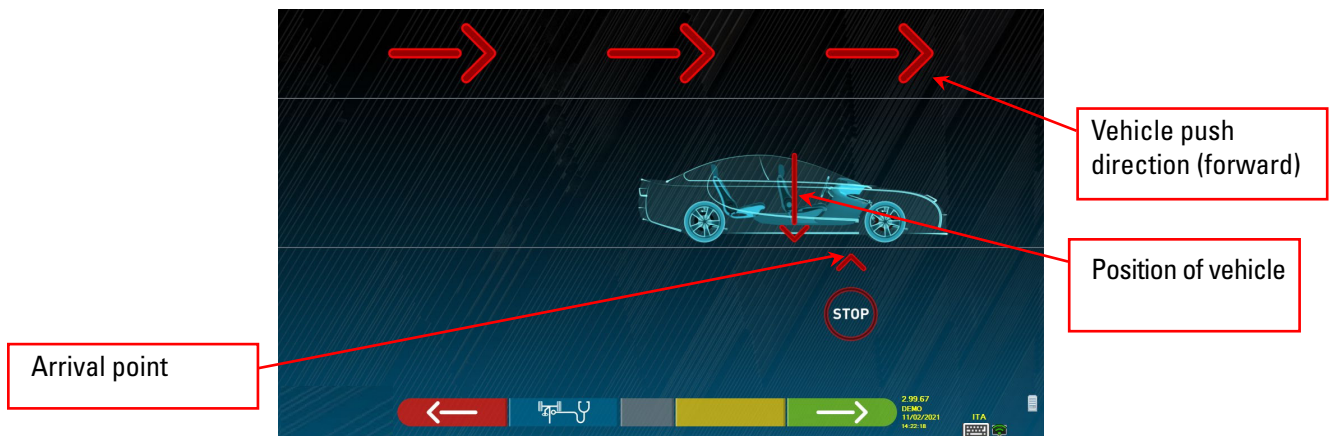

Figure 33

To perform the push off center operation, it is advisable to carefully follow the visual instructions that appear on the screen.

When ready, move the vehicle forward very slowly until the arrow of the vehicle matches the point of arrival.

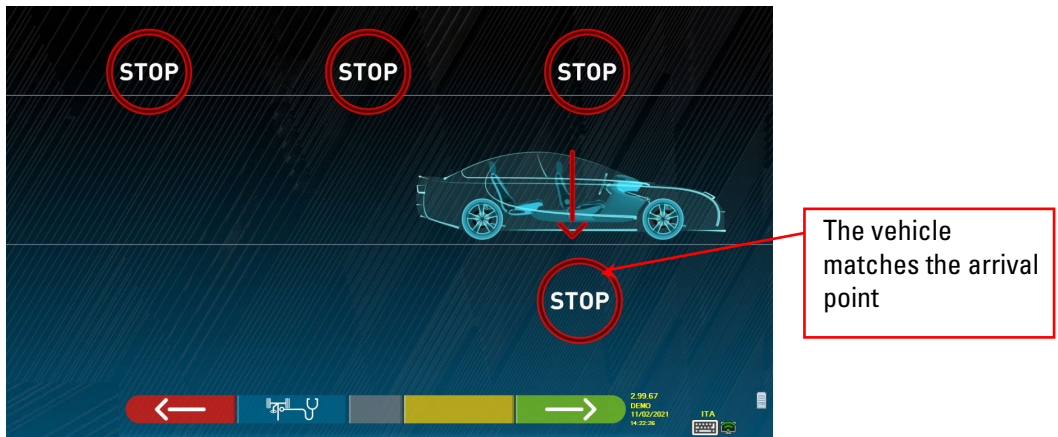

Figure 34

“STOP” is displayed for a few seconds, that is the time necessary for the program to acquire the measurements, after which the program displays the screen indicated below: Start moving the vehicle backwards, very slowly, until the arrow of the vehicle matches the point of arrival.

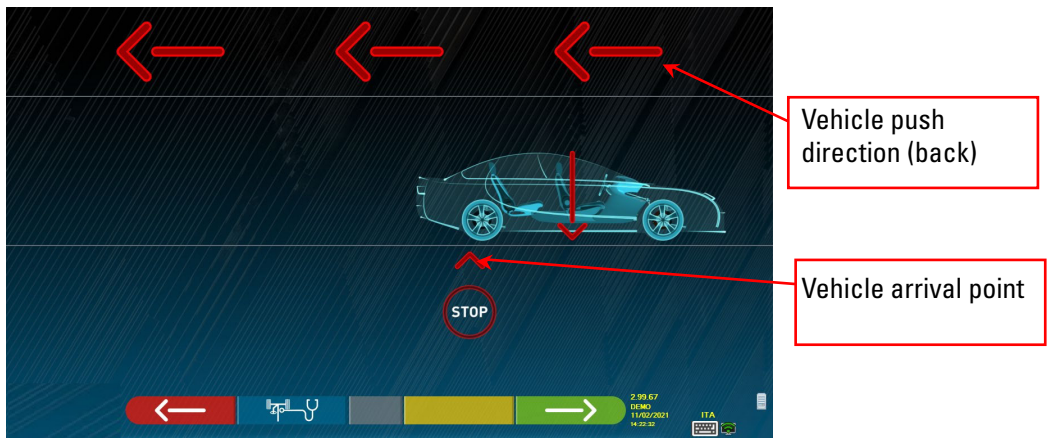

Figure 35

As soon as the vehicle matches the arrival point, “STOP” is displayed for a few seconds, that is the time necessary for the program to acquire the measurements, after which the program displays the following screen:

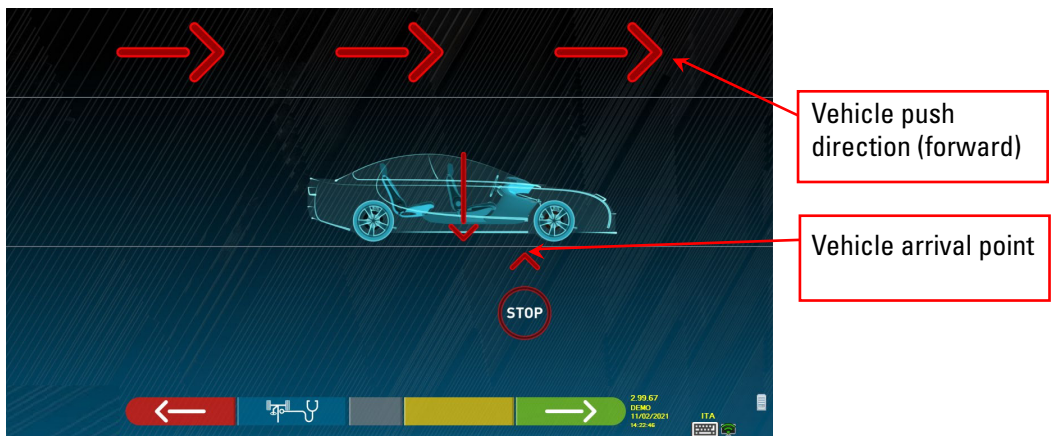

Figure 36

Move the vehicle forward again, until the arrow of the vehicle matches the arrival point (return to the starting position in the center of the plates), “STOP” is displayed for a few seconds, the measurements are acquired. The push off centre procedure has been performed.

To repeat the operation, having already advanced in the program, it is possible to return to this page by pressing the F1 key and then repeat the operations mentioned above. When the run-out has been performed, the program automatically proceeds to the next step.

10.6. Preparing for measurements

After carrying out the run-out procedure, as explained in para. 10.5 on p. 31-32, it is necessary to prepare the vehicle for the measurements. The following screen will appear:

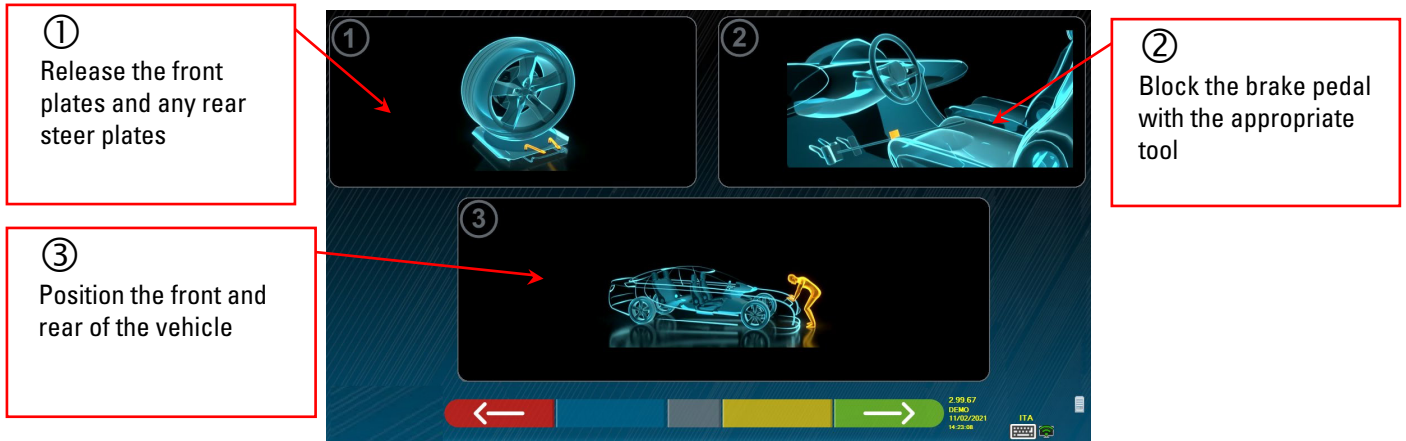







Figure 37

	SENSOR KEYPAD	PC KEYPAD	DESCRIPTION
			Returns to the run-out procedure (see para. 10.5 on p. 31)
			Continues to the alignment procedure (see para. 10.7 on p. 34)

- 1) Release the front plates and any rear steer plates
- 2) Brake the wheels with the handbrake and lock the brake pedal with the appropriate tool (it is necessary in the case of steering for the correct calculation of the KPI).
- 3) Position the front and rear of the vehicle (only necessary if the vehicle was previously raised and the suspension discharged).

Press the key  to continue.



10.7. Aligning of the vehicle / direct measurements

To perform the vehicle alignment procedure and the consequent detection of direct angles, it is necessary to have first performed the measurement preparation operation as explained in para. 10.6 on p. 33.

When alignment is achieved, the "STOP" sign image appears, indicating that the program is acquiring the



Figure 38

	SENSOR KEYPAD	PC KEYPAD	DESCRIPTION
			Returns to preparation of the measurements. (see para. 10.6 on p. 33)

vehicle data measurements. The program proceeds automatically only after the wheels have been aligned.

10.8. Steering procedure

Once the wheels have been aligned (see para. 10.7 on p. 34), it is possible to perform the steering procedure, designed to determine the measurements of:

- CASTER
- KPI/SAI
- Included Angle

(*) Type of steering to be performed:

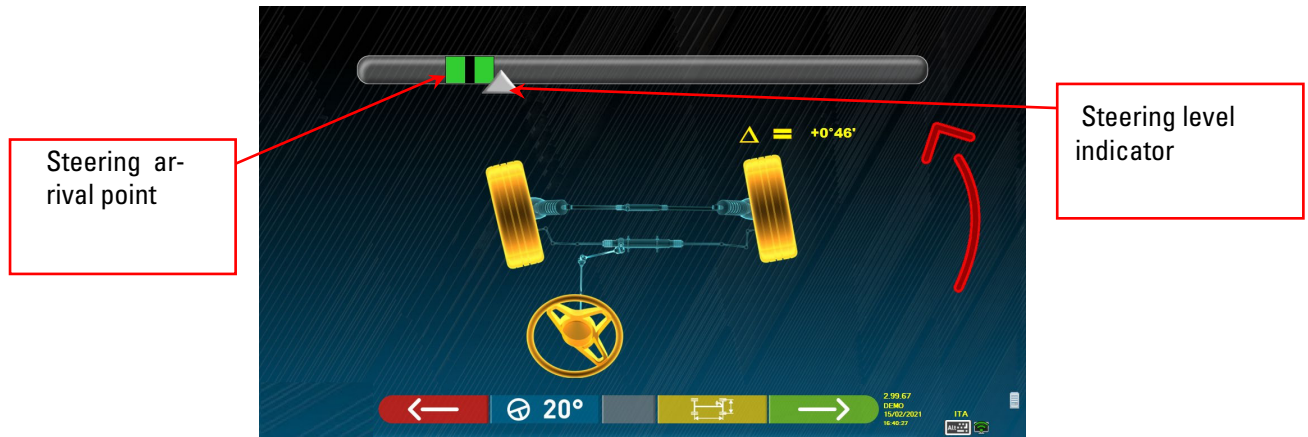

Figure 39

	SENSOR KEYPAD	PC KEYPAD	DESCRIPTION
			Repeats the alignment and levelling procedure (see para. 10.7 on p. 34)
			Press this key to select the type of steering to be performed. (*)
			displays the graphic-geometric representation of the vehicle axles (see para. 10.14.1 on p. 44)
			Displays the vehicle diagnosis page (see para. 10.9 on p. 36)

- 20° steering
- ACK steering (20° with steering geometry)
- Steering at 10°
- Maximum steering

The steering procedure can also be skipped: the measurement values of the data indicated above will not be obtained. To skip the procedure, select the F4 key and view the vehicle diagnosis page directly.

If the procedure is not performed but it is decided to perform it anyway at the end of the adjustment, it is possible to select the appropriate option in the menu.

10.9. Vehicle diagnoses

After carrying out the steering procedure (see para. 10.8 on p. 35), a summary page of the diagnosis is presented which displays a summary of the measurements taken (Figure 40).

The left side shows the reference data of the vehicle selected in the database, on the right side instead, the measurements carried out in diagnosis are reported; the values are highlighted in green if within the tolerance, in red if out. Instead, they are shown with a grey background if there is no tolerance for that angle.

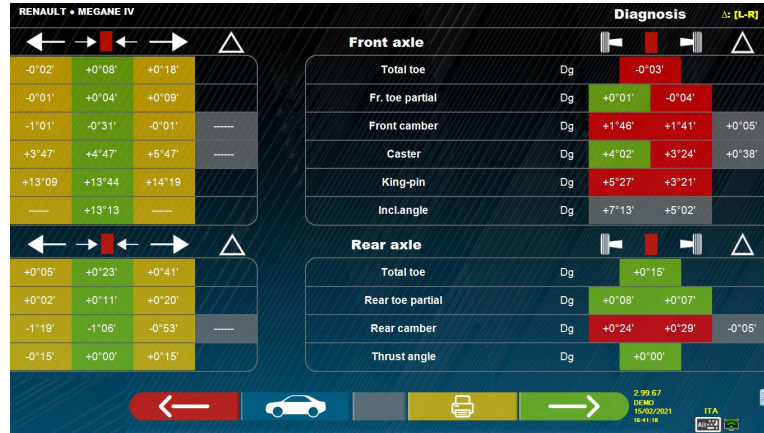

Figure 40

	SENSOR KEYPAD	PC KEYPAD	DESCRIPTION
			Repeats the steering procedure. (see para. 10.8 on p. 35)
			Displays the vehicle technical data (can be changed if necessary). (see para. 10.4 on p. 27)
			Allows printing of the measurements taken of the diagnosis (see para. 10.15 on p. 45).
			Displays the vehicle adjustment preparation page (see para. 10.10 on p. 36)

At this point the vehicle can be prepared for adjustment (see para. 10.10 on p. 36), confirming with the F4 key.

10.10. Preparation for adjustment

By selecting the F4 key from Figure 40 (see para. 10.9 on p. 36), it is necessary to prepare for adjustment. Follow the visual instructions that appear on the screen to complete the preparation for adjustment. Press the F4 key to continue.

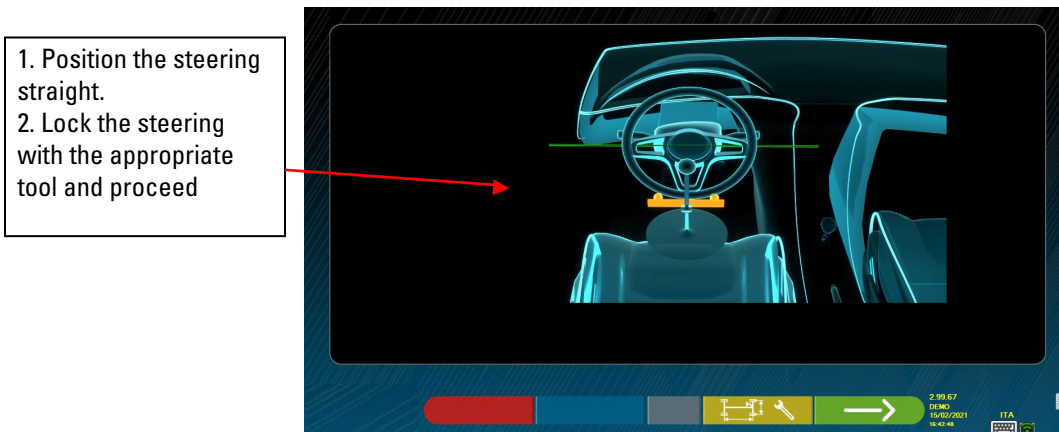

Figure 41

10.11. Rear axle adjustment

The rear axle adjustment procedure is reached by pressing the F4 key shown in Figure 47, after performing the adjustment-preparation operations (see para. 10.10 on p. 36).

Record, where permitted, in the following order:

- Rear camber - Rear partial toe



Figure 42

	SENSOR KEYPAD	PC KEYPAD	DESCRIPTION
			Displays graphic images (only if present in the Database) to help you record the angles (see para. 10.4.3 on p. 30)
			"Jack-Hold" procedure (adjustment with wheels raised)
			displays the graphic-geometric representation of the vehicle axles (see para. 10.14.1 on p. 44)
			Continues with front axle adjustment. (see para. 10.12.1 on p. 39)

Note: For the RWA3D1090 series, during the adjustment phase, it is possible to associate the angle adjustment to a "Beep" sound (they can be set in the "Sound Configuration" option of the "Application Configuration" menu - see para. 9 on p. 17).

By pressing the space bar, a symbol appears below the angle indication and a "Beep" will be emitted with a variable frequency in relation to the value itself.

Beep with very slow frequency → value out of tolerance

Beep with slow frequency → value near the tolerance

Beep with fast frequency → value in tolerance

Continuous beep → value exactly in the centre of the tolerance

Press the space bar repeatedly to move the symbol that matches the association of the sound to the angle to be recorded. Press the space bar again to remove the symbol and thus to deactivate the "Beep".

10.12. Front axle adjustment

The front axle adjustment procedure can be reached by selecting it on the rear axle adjustment page (Figura 57) and after performing the adjustment preparation operations (see para. 10.10 on p. 36).

The recommended order of the angles to be recorded is as follows: CASTER – CAMBER – TOE

ATTENTION: By entering this phase, the incidence values are “FROZEN” (there is a grid over the incidence values indicating that they are “frozen”).

To unfreeze these values, press the F5 key  to bring the selection  on the INCIDENCE value, then press the F1

key (on this occasion it is represented by the icon ). Or advance to the summary (see para. 10.13 on p. 41) and press F1, the program will display an auxiliary function menu page (see para. 10.14 on p. 43), then select “Record incidence”.

Having recorded the incidence values, or even if they are not recorded and they are found to be correct, it is advisable

to “FREEZE” them again; Press F1  again and the grid will appear over the incidence values, indicating that they are “frozen”.

Then perform adjustment of the front axle

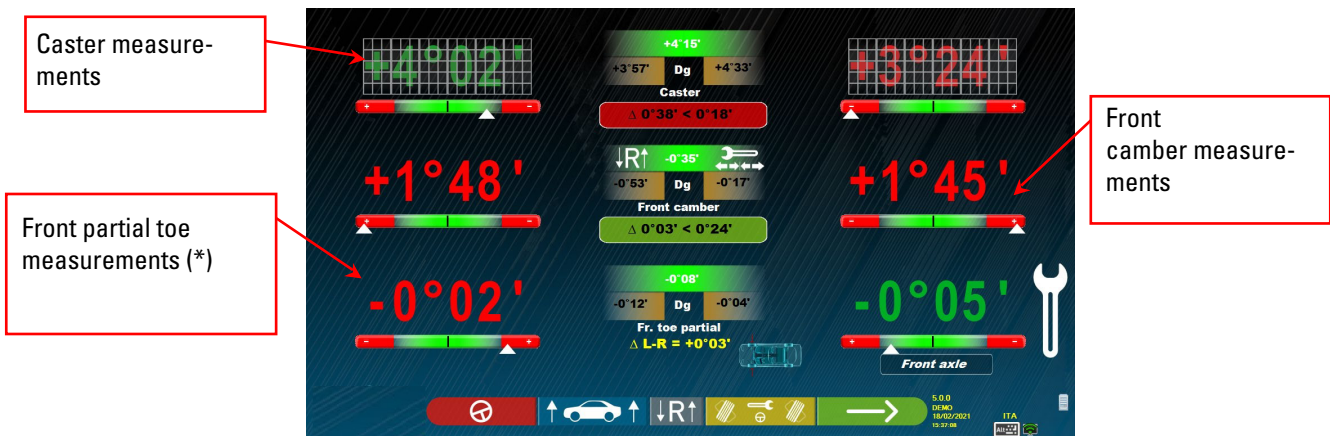



















Figure 43

	SENSOR KEYPAD	PC KEYPAD	DESCRIPTION
			Repeats the steering procedure. (see para. 10.8 on p. 35) *by selecting  on INCIDENCE (appears ) freeze/unfreeze the values
			“Jack-Hold” procedure (adjustment with wheels raised)
			Select  the Castor/Camber: Displays tolerance on LED for RWA3D1090 (see para. 3.3.1 on p. 9)
			It carries out toe-in adjustment with steered wheels (See para. 0)
			Repeats the adjustment operations (see para. 10.11 on p. 37)

(*) It is possible to display alternatively the partial toe or the total toe, by pressing the Shift + F5 keys simultaneously.

10.12.1. Front toe in adjustment with steered wheels

Front toe-in adjustment procedure with steered wheels is started by pressing F3 from front adjustment page.



from front adjustment page.

The Figure below appears, prompting to steer Left or Right and then press F5 to confirm.

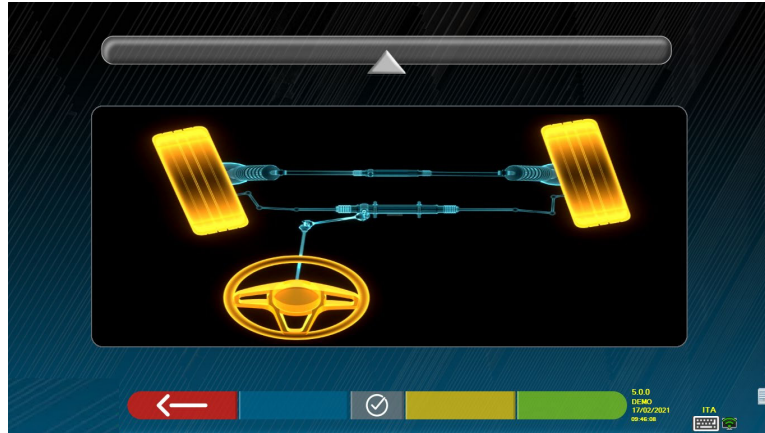

Figure 44

Note: The steering level indicator is displayed only to give the operator feedback on the value that must remain within the maximum alignment reading (approximately 22÷24°).

After pressing F5, the page indicated in Figure 45. appears. To record the partial toe, it is necessary to “defrost” with F2



(LH partial toe) or F3



(RH partial toe).

Having finished adjustment, press the F1 key



to go back to the front adjustment phase (see para. 10.12 on p. 38). The program prompts steering back to center before displaying the front adjustment page (Figure 43).

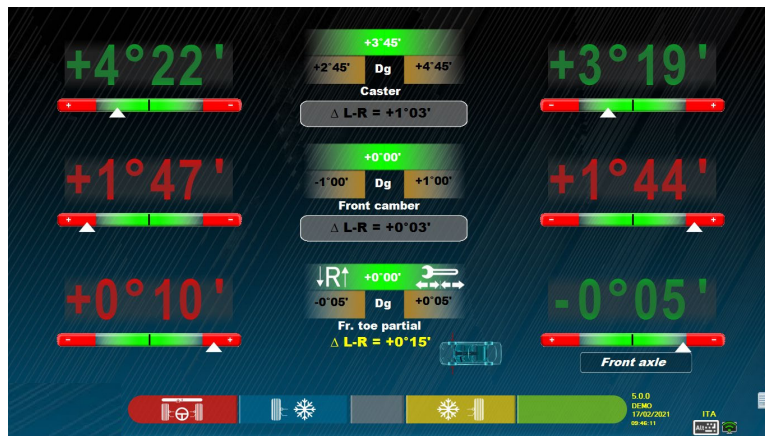



Figure 45

10.12.2. "Jack-Hold" Procedure

From the measurement adjustment page (see para. 10.11 on p. 37 and see para. 10.12 on p. 38) press the key  to carry out the JACK-HOLD procedure (adjustment with wheels raised). Follow the visual instructions that appear on the screen: Lift the vehicle

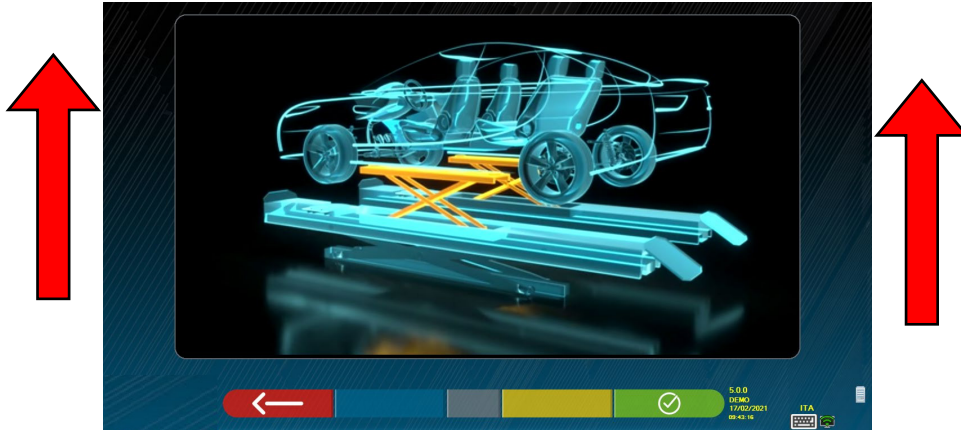



Figure 45

When the vehicle is raised, press the button  to confirm; with the vehicle raised it is now possible to record.

By pressing the key  it is possible to pass from the rear to the front adjustment and vice versa;







When the vehicle is raised, the icon  takes on the appearance  with the down arrow



Figure 46

Then  to switch from rear to front and vice-versa

At the end of the adjustment, press the button  to lower the vehicle and confirm with the key  when it is correctly placed on the rear steer.

At this point, the program displays the adjustment data again (see para. 10.12 on p. 38) press the key  to display the summary page (see para. 10.13 on p. 41)

10.13. Summary of DIAGNOSIS and ADJUSTMENT data

This screen appears following completion of all the adjustment on the vehicle, after pressing the F4 key in the previous adjustment phase, see Figure 43.

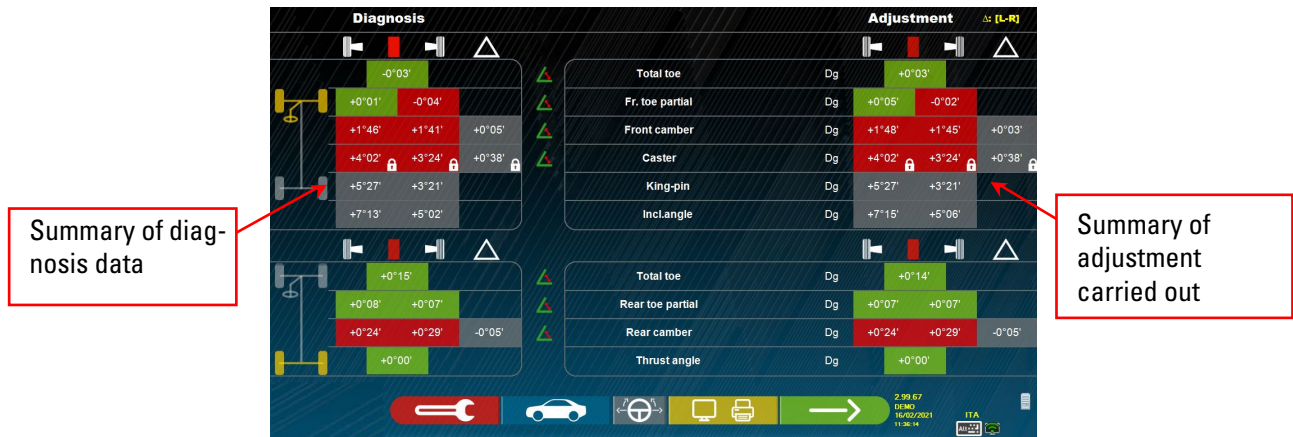

















Figure 47

	SENSOR KEYPAD	PC KEYPAD	DESCRIPTION
			Displays the auxiliary functions menu. see para. 10.14 on p. 43
			Displays the vehicle technical data page.
			Performs the "TEST DRIVE" procedure. see para. 10.13.1 on p. 42
			Operations completed! Customer data entry and printing. see para. 10.15 on p. 45
			Returns to the rear adjustment phase. see para. 10.11 on p. 37

10.13.1. "Test Drive" procedure - steering wheel alignment check

From the measurement summary page (see para. 10.13 on p. 41) press the key  to perform the "Test Drive" procedure (steering wheel alignment check).

Follow the visual instructions that appear on the screen:

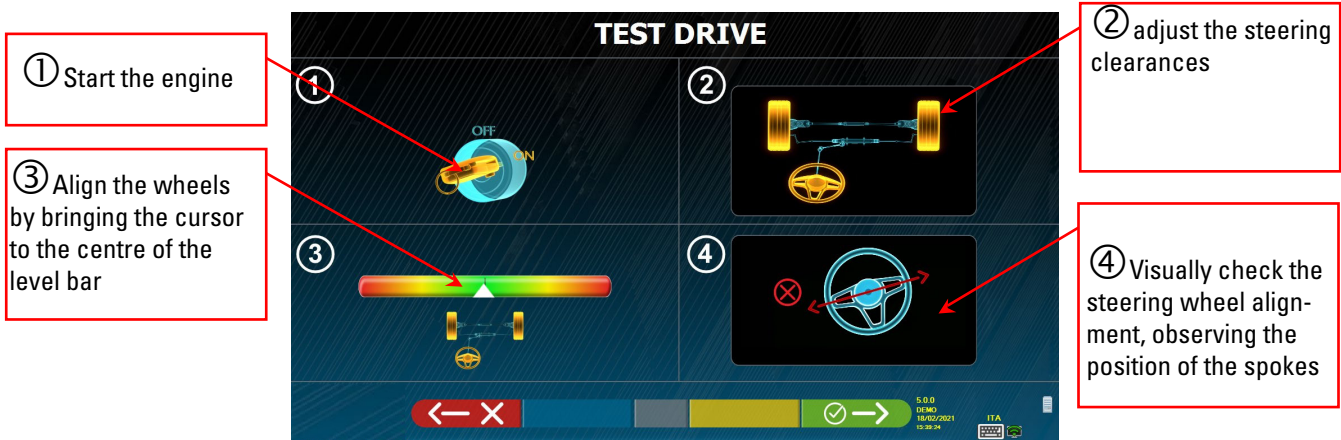



Figure 49

If the "Test Drive" procedure has a positive outcome (the position of the spokes is correct), press the key

 to confirm; the summary page will be displayed again (see para. 10.13 on p. 41) and it will be possible to end the test.

Instead, if the "Test Drive" procedure has a negative outcome (the position of the spokes is not correct) press the key . There will be a prompt to re-check the correctness of the partial toe angles (they must be carefully distributed) in the front axle adjustment procedure (see para. 10.13 on p. 41) and then it will be possible to end the test.

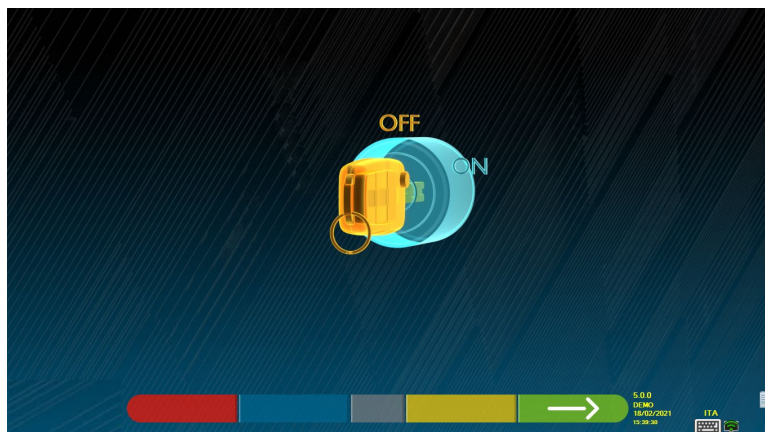



Figure 50

Before continuing, there will be a prompt to turn off the engine. Press the key  to continue.

NOTE: It is necessary to activate the "Miscellaneous 2" option in the menu in advance (see para. 9.2 on p. 19).

10.14. Auxiliary functions menu

To be able to perform certain accessory operations or to be able to repeat some phases of the program, in case

these are not satisfactory or have not been carried out, select the F1 key  on the summary page (see para. 10.13 on p. 41).

Access is provided to a menu of auxiliary functions, which are used to perform the following procedures:

PRELIMINARY OPERATIONS: see para. 10.2.1 on p. 23

TOE CURVE: By following the illustrations that appear on the screen, the toe curve can be recorded as follows: - Position the vehicle, press F4

- Place the appropriate tool under the front axle, press F4

- Adjust the previous partial toe as prescribed by the manufacturer, press F4

- Remove the tool from the axis and press F4, the program returns to the adjustment phase.

CHASSIS DIAGNOSIS: A graphic-geometric representation of the axles of the vehicle being worked on can be displayed, see para. 10.14.1 on p. 44 .

DATABASE: It is used to view the vehicle selection (see para. 10.3 on p. 24) and possibly to select a different vehicle.

CASTER ADJUSTMENT : see para. 10.12 on p. 38.

TEST DRIVE PROCEDURE: see para. 10.13.1 on p. 42

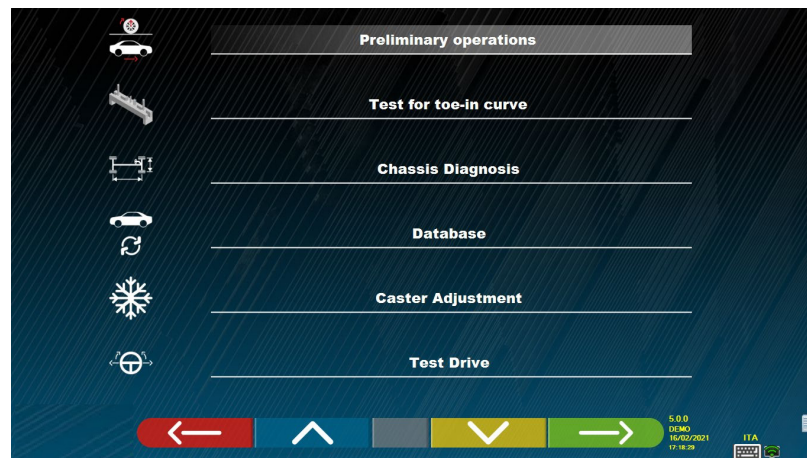













Figure 51

	SENSOR KEYPAD	PC KEYPAD	DESCRIPTION
			Returns to the previous registration page (see para. 10.12 on p. 38)
			Moves the selection up.
			Moves the selection down.
			Confirms the selection.

10.14.1. Chassis diagnosis

By selecting the specific option in the "auxiliary functions" menu" (see para. 10.14 on p. 43), or by pressing the F3 key



during the steering phase (see para. 10.8 on p. 35) or in the rear adjustment (see para. 10.11 on p. 37), a graphical-geometric representation of the axles of the vehicle being worked on is displayed, see the example below.

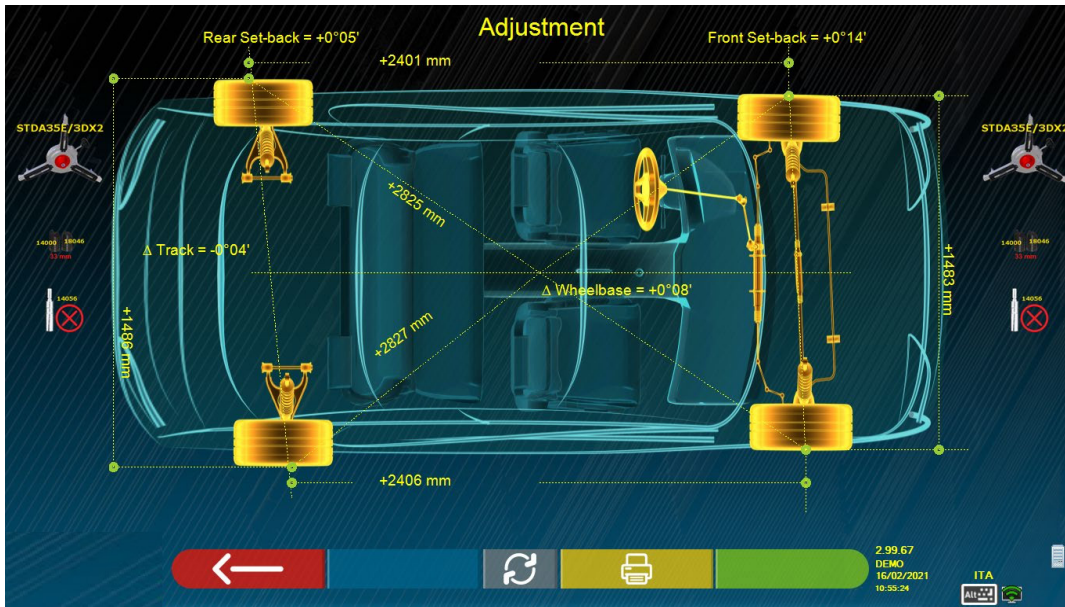

Figure 52

This page displays the distance in mm of the wheelbase and of the track. There are also the diagonals between the four corners of the vehicle's quadrilateral. The measurement of the pitch takes into account the adjustment of the clamps used and the pins / spacers, also represented graphically

This measurement is performed during the vehicle alignment phase (see para. 10.7 on p. 34), for this reason they are considered as "diagnosis" values.

If the vehicle alignment is performed again (e.g. repeated preliminary operation), the values are saved as "adjustment" values;

The display of the "diagnosis" or "adjustment" measurements can be changed by pressing the F5 key



By pressing the F3 key



on this page, the program will allow printing of the "Chassis Diagnosis" measurements.

10.15. Printing of measurements taken

By selecting the following key  on the "SUMMARY" page (see para. 10.13 on p. 41), is presented following screenshot:

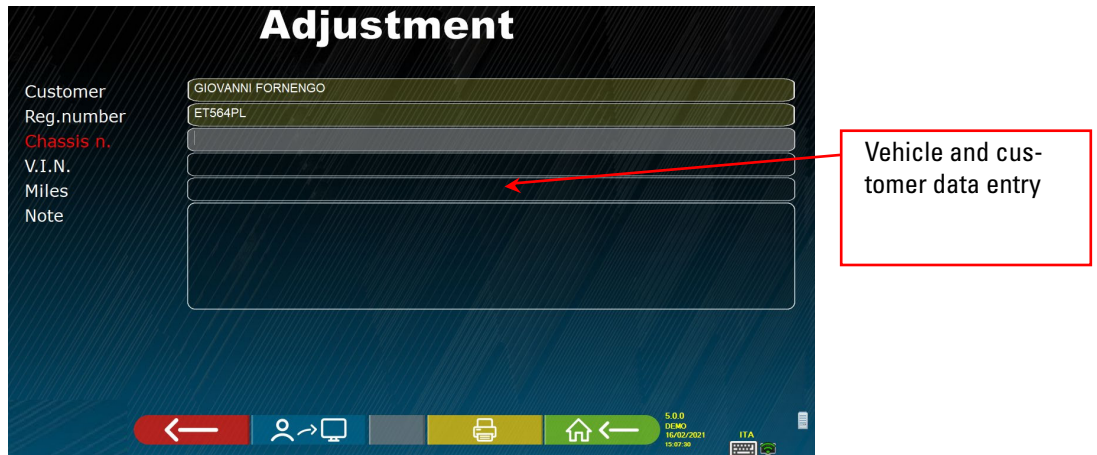















Figure 53

	SENSOR KEYPAD	PC KEYPAD	DESCRIPTION
			Repeats the steering procedure. (see para. 10.8 on p. 35)
			Stores the test in the "customer database" of the tests carried out (*).
			Displays a print preview of the test performed (see para. 10.15 on p. 45)
			Returns to the home page without storing the test

(*) The data contained in the "customer database" can be accessed from the presentation page using the F3 key  (see para. 10.1 on p. 22)

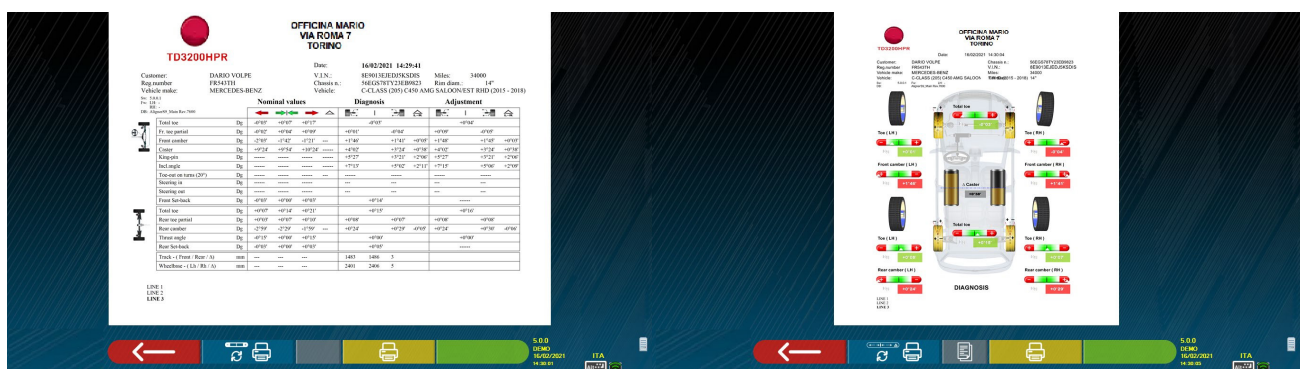











Figure 54

	SENSOR KEYPAD	PC KEYPAD	DESCRIPTION
			Returns to the "vehicle data entry" phase of Figure 53
			It is used to alternate the display between the tabular print and the Graphic print of Figure 54
			Sends the print report to the printer

A report on the test performed is printed which includes the customer's data, the vehicle data before and after adjustment, the technical data of the vehicle provided by the manufacturer and any notes to be expressed to the customer.

Legend of the print example shown in Figure 55

- 1 - Manufacturer's logo
- 2 - Space reserved for customising of the workshop data
- 3 - Date and time of the test
- 4 - Identification data of the vehicle being tested and of the owner
- 5 - Factory data of the vehicle being tested
- 6 - Diagnosis data of the vehicle being tested
- 7 - Data of the vehicle being tested after adjustment
- 8 - Front axle data table
- 9 - Rear axle data table
- 10 - Space reserved for notes that can be entered manually

Example of tabular printing

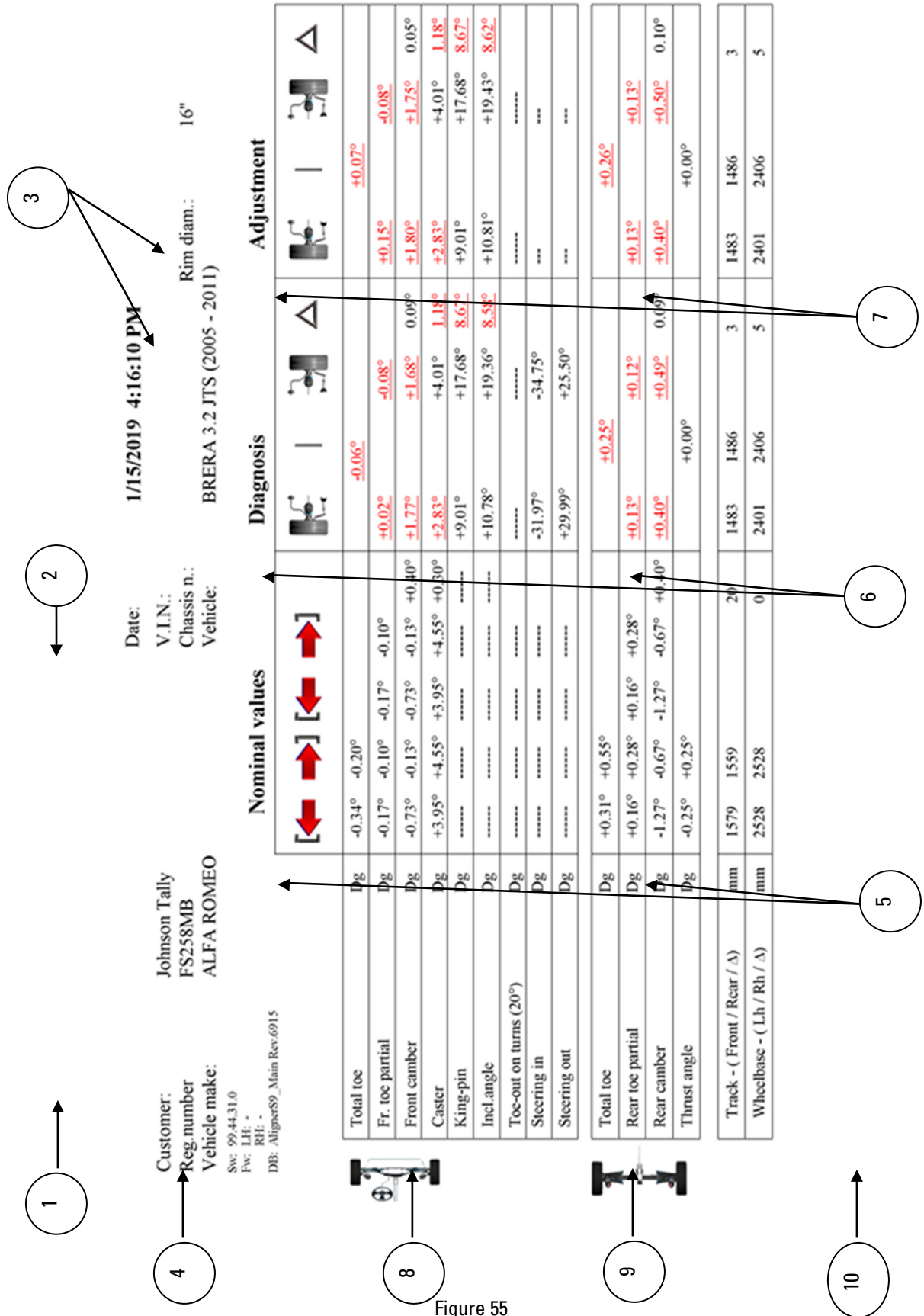
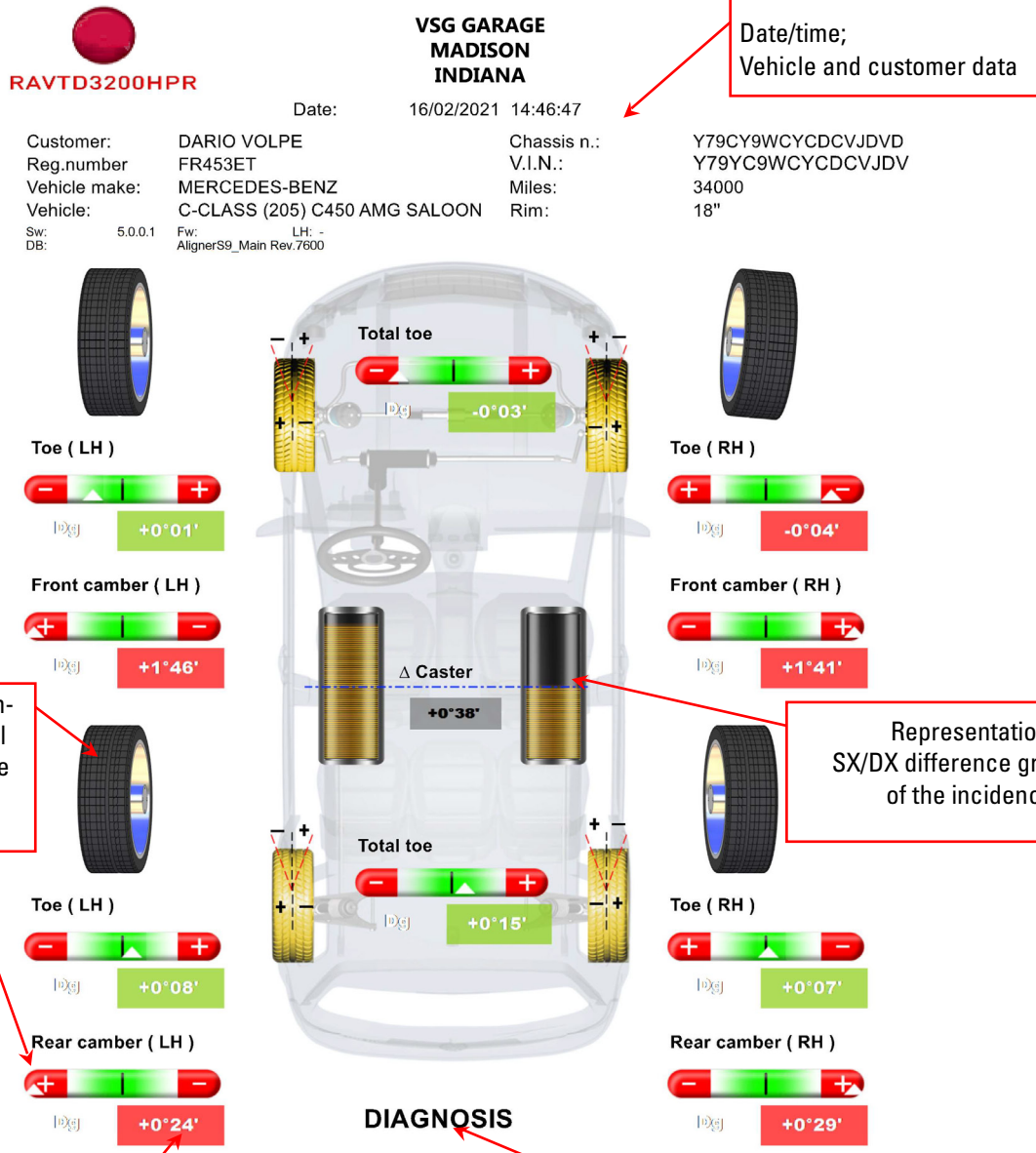

Figure 55

Graphic print example



Graphical representation of the wheel based on tolerance values

Tolerance bar

Value indicated in red / green depending on the tolerance

Representation SX/DX difference graphics of the incidence

Indication of diagnostic and adjustment measurements displayed in red / green depending on the tolerances

Figure 56

10.16. Saving of tests performed with TEq-Link

At the end of the test it is possible to save the report with the results and all the data relating to the vehicle, through the function **TEq-Link**.

It is necessary to install the "TEq-Link Web Manager" software on a Personal Computer connected to the workshop computer network (see the TEq-Link function configuration manual cod. M0215) and to connect the PC of the equipment to the same data structure.

⚠ Attention! *It is necessary in advance to ask the manufacturer to enable the functionality, communicating the number of your Smartcard (see chap. 12 on p. 59) and to configure the PC of the equipment with the references of the PC where the "TEq-Link Web Manager" software is installed (see para. 10.16.1 on p. 49).*

After completing the  test, in the customer data entry phase (see Figure 53 on p. 45), it is possible to store the test results using the key .

When the tests carried out are stored, their results are immediately accessible from any PC or mobile device in the network.

10.16.1. TEq-Link functionality configuration

Before being able to save the test with the TEq-Link functionality, it is necessary to insert the references of the PC where the "TEq-Link Web Manager" software is installed.

Access from the configuration menu (see para. 9 on p. 17) in the TEq-Link application /connection configuration option, then enter the IP address of the PC where the "TEq-Link Web Manager" software is installed. For details see the TEq-Link functionality configuration manual (cod. M0215 in paragraph 3.2).

At this point, from any PC or mobile device on the same network, simply by entering the I.P. or the name of the PC with the "TEqLink Web Manager" SW, to access the main page for managing the saved tests; see example in Figure 57.

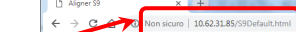
IP or name of the PC with 

Saved tests 

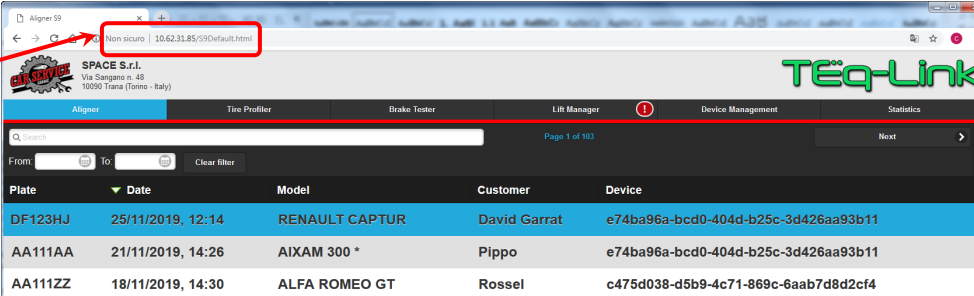

Plate	Date	Model	Customer	Device
DF123HJ	25/11/2019, 12:14	RENAULT CAPTUR	David Garrat	e74ba96a-bcd0-404d-b25c-3d426aa93b11
AA111AA	21/11/2019, 14:26	AIXAM 300 *	Pippo	e74ba96a-bcd0-404d-b25c-3d426aa93b11
AA111ZZ	18/11/2019, 14:30	ALFA ROMEO GT	Rossel	c475d038-d5b9-4c71-869c-6aab7d8d2cf4

Figure 57

11. DATABASE CUSTOMISATION

It is possible to customise the vehicle database by creating customised groups and vehicles.

11.1. Insertion of a new group

To be able to create customised groups and to store them in the database, it is first necessary to go to the groups configuration page (see para. 9.1 on p. 17).

At this point, press the “Ins” key  on the keypad.

The following screen will appear:

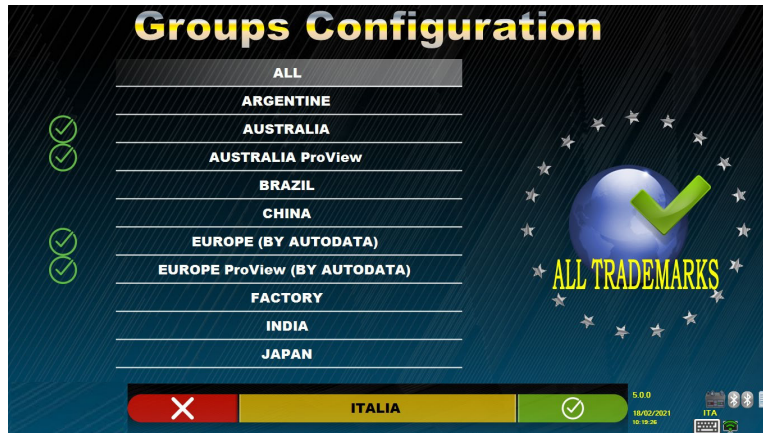



Figure 58

Enter the name of the new profile (in the example in Figura 58 “ITALIA” is indicated) and confirm by pressing F4.



Figure 59

At this point, press F4 to enter the new group “ITALIA” and make the brands visible by pressing

F5  as indicated see para. 9.1 on p. 17. Then make the profile visible by pressing F5 again, as indicated below in Figure 60.

Press F1  to exit.

Selecting the group with the F5 key "All makes", a profile is displayed in which all the vehicles of all the makes present in the database are displayed

New group displayed

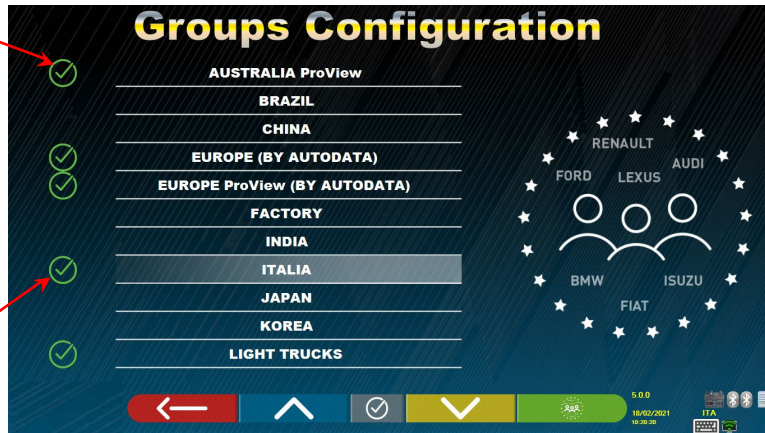

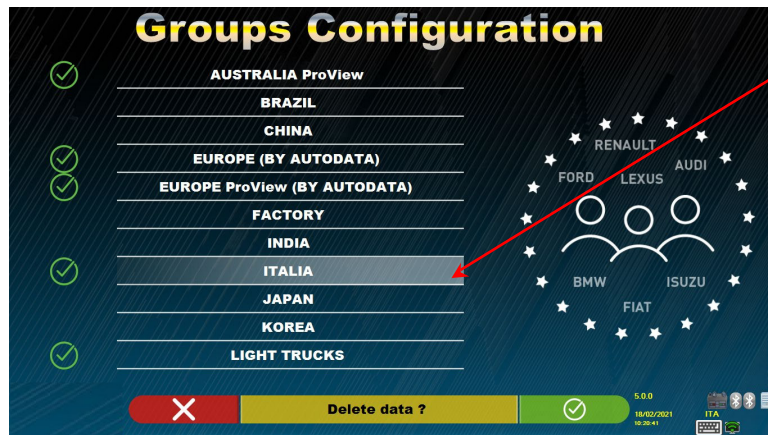

Figure 60

11.2. Deletion of a new group

It is necessary to view the group configuration (see para. 9.1 on p. 17), select the customised group to be deleted, then press the "delete" key: : and confirm with F4.



Customised group displayed

Figure 61

Attention: If a customised group is deleted, it will no longer be possible to recover it, unless in possession of a backup copy of the database.

11.3. Insertion of a new vehicle

ATTENTION:

In order to create customised vehicles and to store them in the database, it is necessary to start from a "dummy" vehicle (without values) or from an unofficial vehicle (from historical sources, which are highlighted by an asterisk next to the name). The official data is protected by copyright, it is not possible to use it to create a new vehicle.

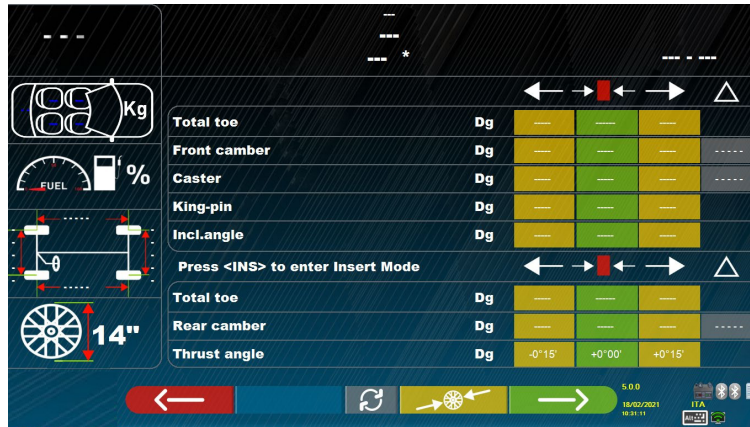

Figure 62

At this point it is necessary to press the "Ins" key on the keypad:







The following screen will appear:



Figure 63

As can be seen in Figure 63 in the highlighted point, the make of the selected vehicle appears highlighted with the red background. It is possible to enter or confirm the name of the vehicle make to be created. Next, select and enter:

- Vehicle model and sub-model name
- Production start and end date
- Rim diameter
- Front and rear track
- Left and right pitch

	They move the selection to the next data.
	They move the selection to the previous data.
	Deletes the entire selected element
	Deletes the last character of the selected element

Use the following keys:

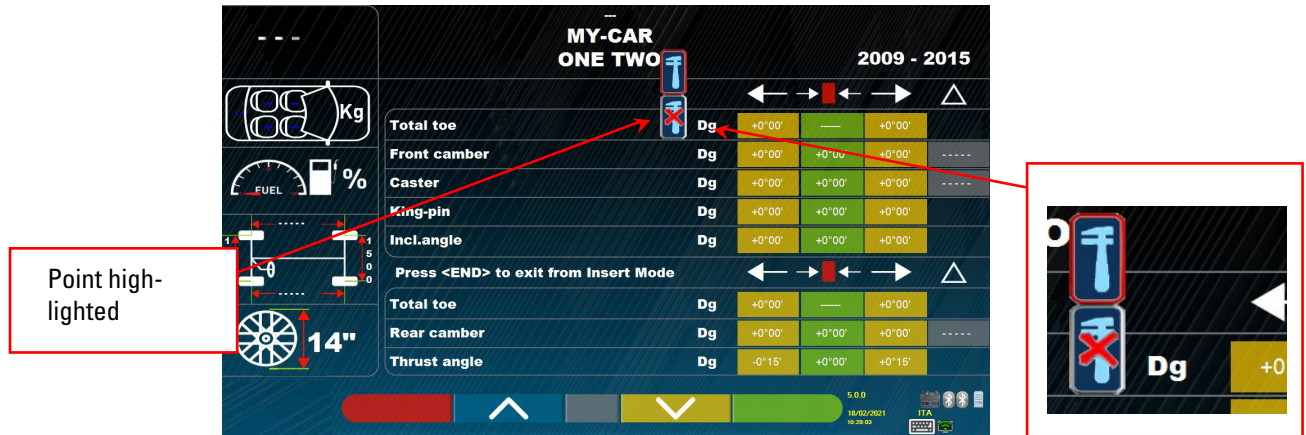

Figure 64

After entering the above data, the screen will look like this:

As can be seen in the enlargement on the right of Figure 64, it is necessary to specify whether the angle is adjustable

or not. Use the keys / to set the selection to "adjustable" or "non-adjustable" . It is now necessary to enter the vehicle tolerance values of the Toe and Camber angles; for the front axle it is also possible to enter: Caster, KPI and steering data.

Attention: To separate integer values from decimals, try using the "full stop" or "comma" .

At the end of entering the values, press the key , the following screen appears:

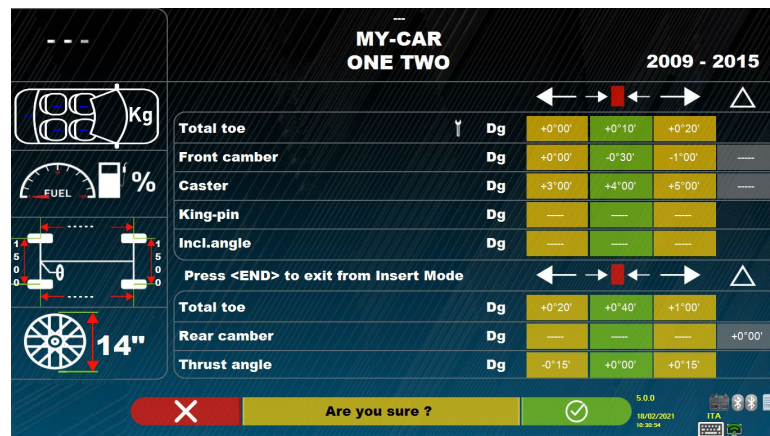

Figure 65

confirm with creation of the customised vehicle.

If viewing the vehicle database, it can now be seen that the newly created customised vehicle is also present, it is there separately from the other brands, always in alphabetical order, written in italics.

11.4. Deletion of a customised vehicle

It is necessary to view the vehicle database page and to select the customised vehicle to be

deleted, then to press the Delete key:

Attention: If a customised vehicle is deleted, it will no longer be possible to recover it, unless in possession of a backup copy of the database.

12. SMARTCARD FOR PROGRAM AND DATABASE PROTECTION

3D devices are all equipped with a PC and a SMARTCARD reader.

The afore-mentioned SMARTCARD inserted in the reader allows the program itself to function and also enables access to the vehicles DATABASE.

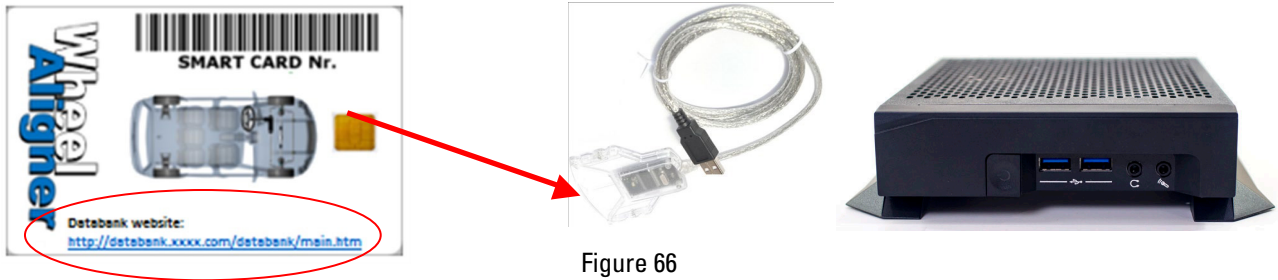

Figure 66

Each device is provided with its own unique SMARTCARD which cannot be replaced with one from another device.

In case of removal or replacement of the afore-mentioned SMARTCARD, the program displays an error message similar to the one shown in - Figure 67 -, and it will not be possible to continue.

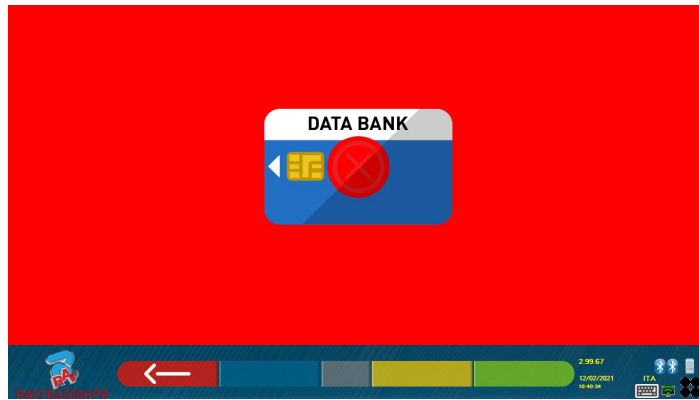

Figure 67

To download the two files required for installation: (the token and the database) it is necessary to go to the databank website indicated on the SMARTCARD, see Figure 68.

Contact your dealer for details on how to download on the manufacturer's website

12.1. DATABASE management

To install or update a new database, always refer to the manual cod. M0251 downloadable from the databank site highlighted in your SMART CARD.

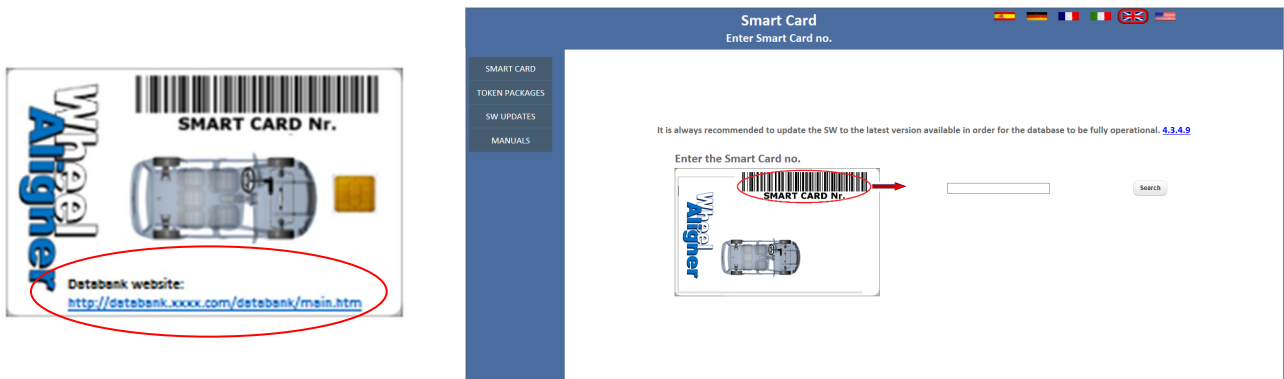
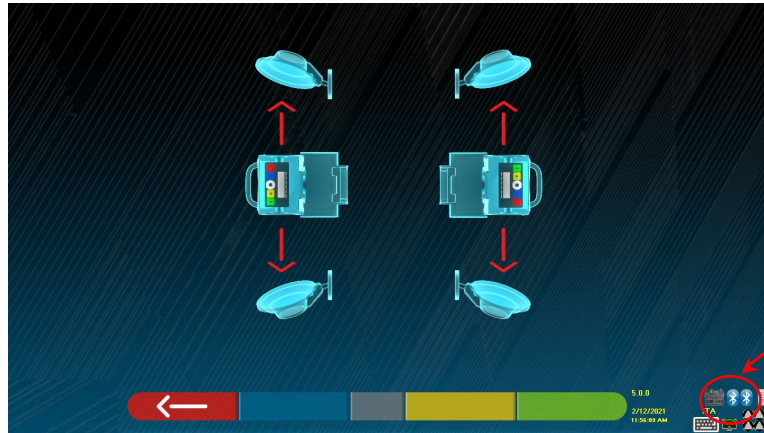

Figure 68

13.ERRORS DURING MEASURING

13.1. Measuring heads data transmission / receiving error / target non-identification errors target identification.

During data transmission/reception between the measuring heads and the cabinet, the following screen may appear:



Symbols indicating bluetooth communication status with SX and DXheads

Figure 69

This may indicate that there is an anomaly due to one or more of the following problems:

- The camera is hidden (cap inserted).
- There is an obstacle between the target and the camera.
- The target is not mounted or not mounted in the correct position (ssee para. 10.2.2 on p. 23)
- The camera is faulty

One of the following screens may also appear:

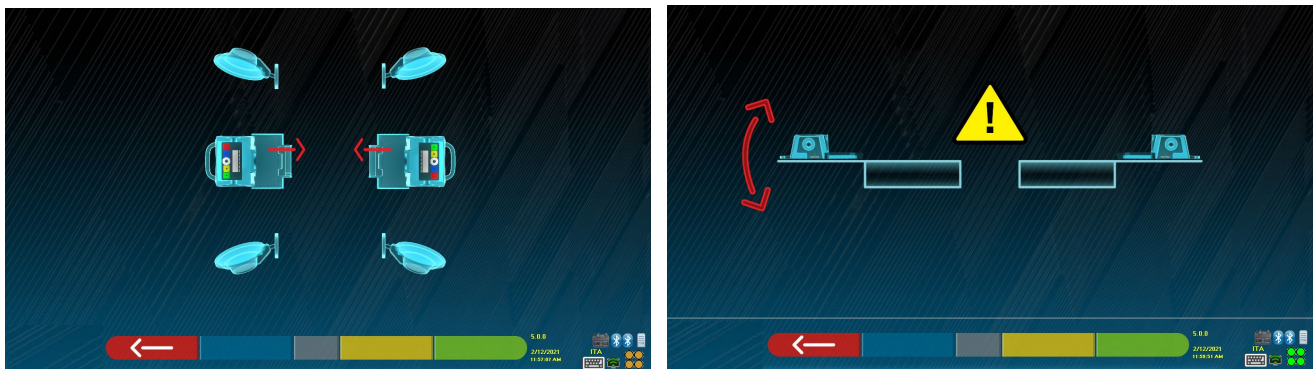

Figure 70

This may indicate that there is an anomaly due to one or more of the following problems:

- A measuring head is excessively inclined (it must be adjusted with the appropriate set screws).
- A side camera is hidden
- There is an obstacle between the side cameras.
- The side camera is faulty

If the cause of the malfunction is removed (e.g. The obstacle is removed) the error page disappears immediately and the measurement page reappears on the monitor. If the problem persists, it is necessary to check the system hardware by first turning off the equipment. Of course it is highly recommended not to remove the power supply to the cabinet immediately, but it is necessary to follow the correct shutdown procedure:

- Press the "Esc" key on the keypad to return to the presentation page (see para. 10.1 on p. 22).
- Proceed with the usual shutdown of the equipment (see para. 6.2 on p. 15).

The “Bluetooth” symbols in Figura 70, indicating the communication status, can indicate the following conditions, according to the colour:

- There is a fault or radio interference in the transmission system with the measuring heads.
- The measuring head(s) are faulty or switched off.

If both symbols are BLUE, the error in Figure 69 may indicate that there is a anomaly concerning the failure to identify the target(s).



NO Communication

If one or both of the symbols are GREY, a transmission/reception anomaly is indicated.



OK communication

Check that the Bluetooth communication with the measuring heads is activated (both symbols must be BLUE).

14. PROBLEMS

Listed below are some possible problems of the wheel alignment equipment.

Rotary disclaims any liability for damage caused to persons, animals and property due to the intervention of unauthorised personnel and to the use of non-original spare parts.

Before carrying out any work on the system, it is necessary to disconnect the power supply.

If in doubt, do not interpret, contact the Rotary technical assistance in advance in order to receive information to be able to perform operations in conditions of maximum safety.

PROBLEM	CAUSE	SOLUTION
NO OPERATION	- No voltage in the network - Protection fuses interrupted	- Check the mains voltage - Check the protection fuses
The monitor does not work		- Check the connection of the power cable - Check the connection of the video signal cable between the PC and the monitor
The PC does not turn on	- No power supply	- Check the ON/OFF switch of the PC - Check the power cable connection
The printer does not work (see also printer operating manual)	- No power supply - No signal	- Check the ON/OFF switch - Check the connection of the power cable - Check connection of the printer signal cable with the PC

15. MAINTENANCE

ATTENTION! Before carrying out any maintenance work it is necessary to disconnect the machine from the network by turning off the general power supply. To clean plastic panels or shelves, use alcohol (IN ANY CASE, AVOID LIQUIDS CONTAINING SOLVENTS). The DISPLAY must be cleaned with a dry cloth; if it is particularly dirty, clean it with a damp cloth and then dry. Do not spray alcohol directly onto the control panel and avoid cleaning with strong jets of compressed air. Keep the methacrylate filters of the optical unit clean using a slightly damp cloth, do not use solvents; Cleaning, cartridge replacement and other printer maintenance operations are described in the manual supplied with the printer. Always refer to the latter before carrying out any maintenance on the printer.



16. STORAGE AND SCRAPPING

Storage - In the event of long-term storage, it is necessary to disconnect the power sources and to provide protection for the display which could be damaged due to excessive dust deposits. Grease the parts that could be damaged in case of drying.

Scrapping - Should you decide to no longer use this device, it must be made inoperative by eliminating the connection cables and the sensitive parts that may become a source of danger. Consider the machine as special waste and dismantle it by dividing it into homogeneous parts. Dispose of the parts according to the local laws in force.



Properly dispose of items in accordance with all local and national procedures/codes



The main structure of the enclosure bears the recycling symbol; it is made of linear medium density natural polyethylene, a material that can be recycled.

17. MACHINE IDENTIFICATION DATA

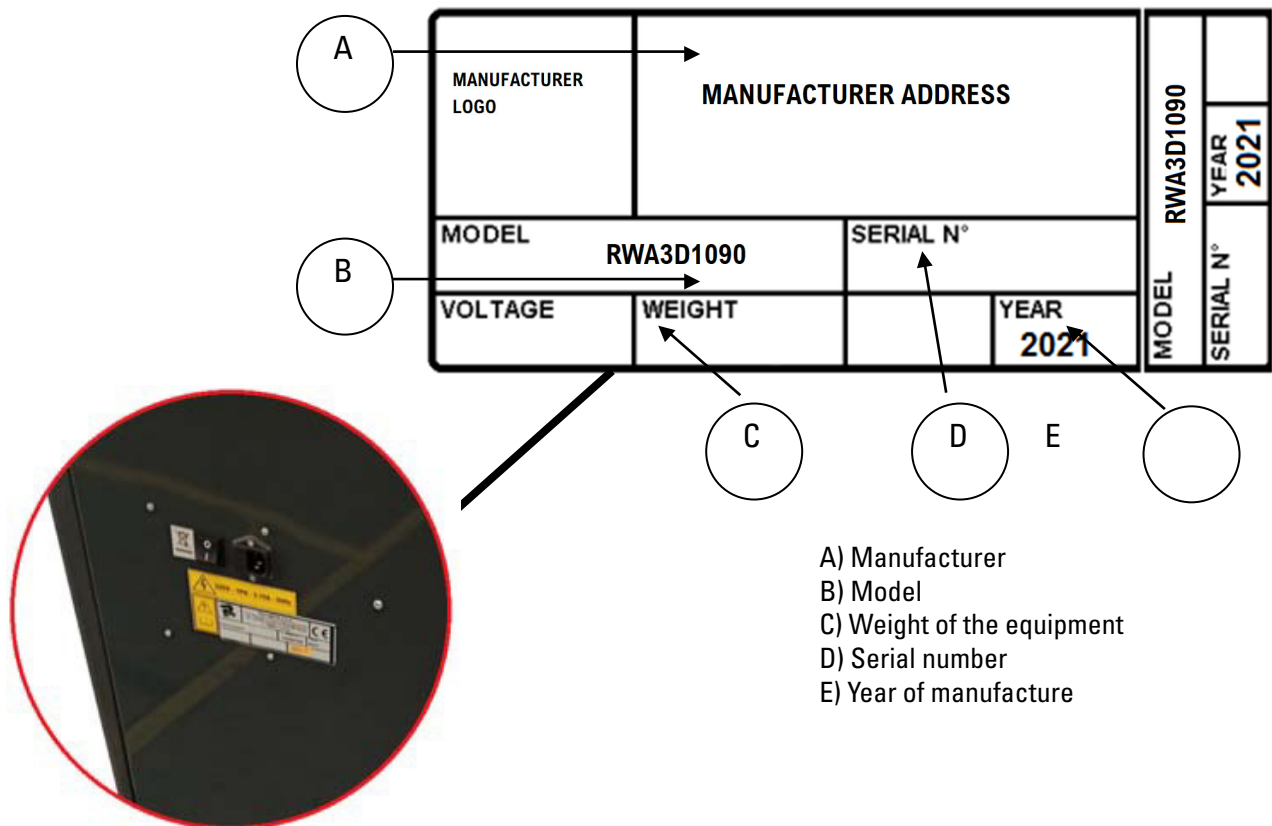

ATTENTION: It is absolutely forbidden to tamper with, engrave, alter in any way or even remove the machine identification plate; do not cover this plate with temporary panels, etc. as it must always be clearly visible.

Always keep this plate clean from grease or dirt in general.

WARNING: In the event that for accidental reasons the identification plate is damaged (detached from the machine, damaged or even partially illegible) immediately notify the manufacturer of this fact.

Rotary World Headquarters

2700 Lanier Drive
Madison, IN 47250, USA
www.rotarylif.com

North America Contact Information

Tech. Support:
p 800.445.5438
f 800.578.5438
e userlink@rotarylif.com
Sales:
p 800.640.5438
f 800.578.5438
e userlink@rotarylif.com

World Wide Contact Information

World Headquarters/USA: 1.812.273.1622
Canada: 1.905.812.9920
European Headquarters/Germany: +49.771.9233.0
United Kingdom: +44.178.747.7711
Australasia: +60.3.7660.0285
Latin America / Caribbean: +54.3488.431.608
Middle East / Northern Africa: +49.771.9233.0

© Vehicle Service Group™

Printed in U.S.A., All Rights Reserved. Unless otherwise indicated, ROTARY, and all other trademarks are property of Dover Corporation and its affiliates.

